



Surgical Drapes, Gowns and Ancillary Products



Distributed by



Cardinal Health provides a complete selection of surgical drapes, gowns and ancillary products that offers patients and clinicians the protection they want and need.

Our enhanced line of Tiburon® Surgical Drapes provides improved drapeability*, additional cord management features* and AAMI level 4 protection. Additionally, our surgical gowns offer AAMI level 3 (Astound® Surgical Gowns) and AAMI level 4 protection (SmartGown™ Surgical Gowns) to help keep you safe from potentially harmful elements, allowing you to focus on what matters most – your patients. In developing our portfolio of products, we worked closely with healthcare professionals, like you, to make sure that your needs and expectations were not just met, but exceeded.

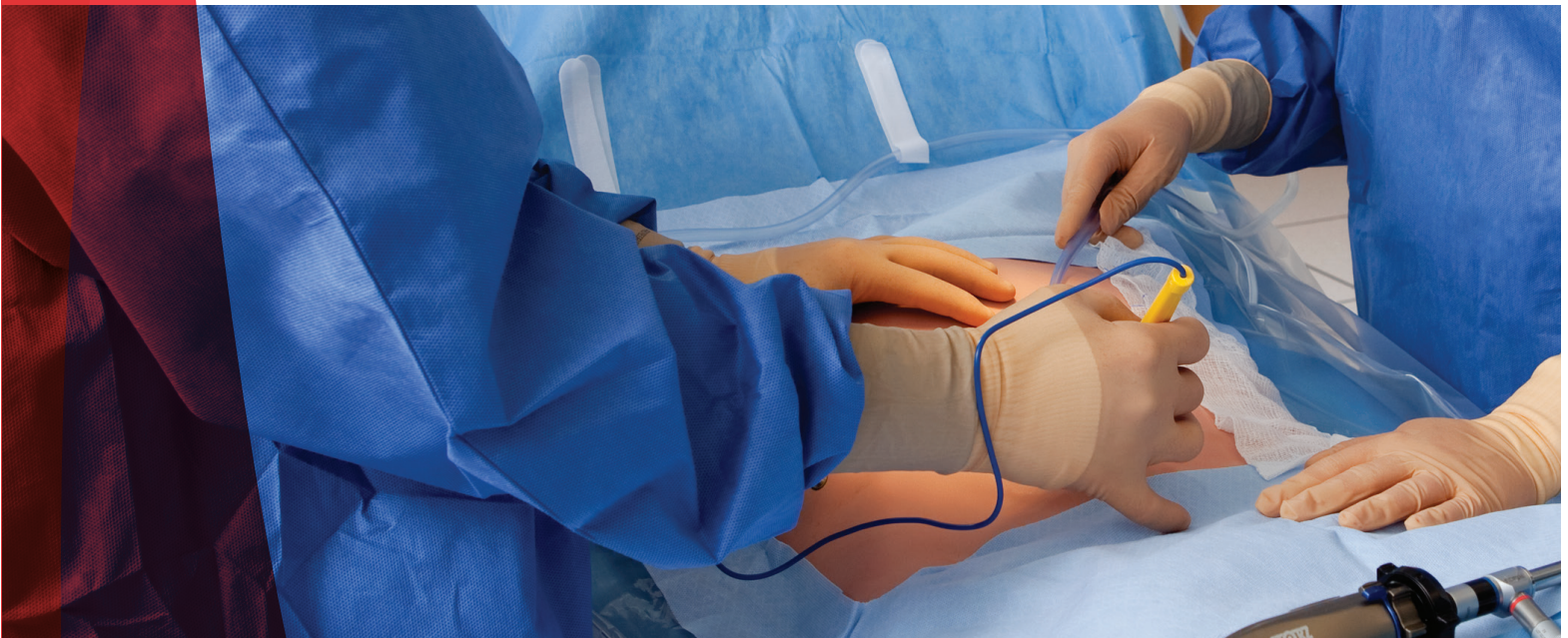

*As compared to prior Tiburon® Surgical Drape design.
AAMI Levels determined per ANSI/AAMI PB70:2012

Contents

Surgical gowns	5
SmartGown™ Surgical Gowns.....	5
Astound® Surgical Gowns.....	5
Sterile sleeve.....	5
Tiburon® Surgical Drapes and Packs	6–59
Ancillary.....	7–12
Ancillary patient drapes.....	8–10
Drape accessories.....	11
Equipment drapes and covers.....	12
Angiography.....	13–15
Cardiovascular.....	16–18
Central Line.....	19–20
Cystoscopy.....	21–22
General surgery.....	23–26
Neurosurgery.....	27–28
Obstetrics.....	29–31
Ophthalmology and ENT.....	32–37
Orthopedics.....	38–44
Pacemaker.....	45–46
Pediatrics.....	47–48
Peri-GYN.....	49–50
Special procedures.....	51–52
Standard packs.....	53–59
Indexes	60–65
Sterile number index.....	60–61
Nonsterile number index.....	62–63
Product index.....	64–65



Surgical gowns

Be in the know and know you are protected with Cardinal Health™ Surgical Gowns.

Inspired by long days on your feet, our surgical gowns stand up to the rigors of your work, helping to keep you safe from potentially harmful elements.

In creating SmartGown™ and Astound® Surgical Gowns, we worked closely with healthcare professionals like you to make sure your needs and expectations were not just met, but exceeded.



What will you be wearing?

It's important to choose the right gown for the right procedure. While there are many factors that go into choosing the right surgical gown, the questions below may help as you evaluate the different gowns and levels of protection available:

- What type of procedure is being performed?
- How long will the procedure last?
- How much fluid will be present during the case?
- What is the clinician's role in the procedure?²

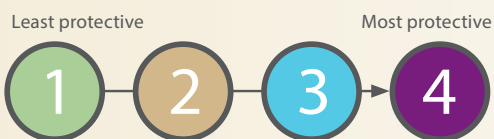

AAMI levels

All surgical gowns are categorized by a barrier performance level which is designated by the AAMI and based on Standard PB70:2012.

All Cardinal Health™ Surgical Drapes and Gowns meet the EN13795 Standard

AAMI Levels determined per ANSI/AAMI PB70:2012

SmartGown™ Surgical Gowns



89013 SmartGown™ Surgical Gowns and 890015N SmartGown™ Surgical Gowns and Scrub Nurse

SmartGown™ Surgical Gowns. Fully Impervious

Sterile No.		Type	Qty. Cs
89015	Large	Set-in Sleeve	20
89045	X-Large	Set-in Sleeve	18
89049	X-Large X-Long	Set-in Sleeve	14
39049	X-Large, X-Long	Raglan Sleeve	14
39075	XX-Large	Raglan Sleeve	14
32474	X-Large, X-Long, A-line	Raglan Sleeve	16
39079	XX-Large X-Long	Raglan Sleeve	14

Surgical Gowns

Astound® Surgical Gowns



9515 Astound® Standard Surgical Gowns and 90270NA Astound® Standard Gowns, Scrub Nurse



9511 Astound® Fabric-Reinforced Gowns and 90970N Astound® Fabric-Reinforced Gowns, Scrub Nurse

Astound® Standard Gowns

Sterile No.	Size	Type	Qty. Cs
ASG9515	Large	Set-in Sleeve	20
ASG9545	X-Large	Set-in Sleeve	20
ASG9575	XX-Large	Set-in Sleeve	18

Astound® Fabric-Reinforced Gowns

Sterile No.	Size	Type	Qty. Cs
ASG9511	Large	Set-in Sleeve	20
ASG9541	X-Large	Set-in Sleeve	18
ASG9541EL	X-Large, X-Long	Set-in Sleeve	18

Astound® Poly-Reinforced Gowns

Sterile No.	Size	Type	Qty. Cs
9010	Large	Set-in Sleeve	20
9040	X-Large	Set-in Sleeve	20
9070	XX-Large	Set-in Sleeve	18
9041EL	X-Large X Long	Set-in Sleeve	18

Sterile Sleeve



Sterile Disposable Sleeve

- Quick sterile coverage for contaminated gown sleeves
- Elastic at both ends for ease of donning
- 21.5 in. minimum length

Sterile No.	Qty. Bx	Qty. Cs
599	30	60/cs

Tiburon® Surgical Drapes and Packs

Tiburon® Surgical Drapes are engineered to pass the industry standard tests that measure fluid penetration to provide AAMI level 4 protection. They are resistant to abrasion and puncture, yet their flexible, cloth-like properties allow them to drape naturally, following the contours of the patient.

Classified as a Level 4 device under the AAMI guidelines for barrier performance in the critical zone, Tiburon® Surgical Drapes provide the highest level of barrier protection available in a surgical drape.

You asked. We Listened.

The next-generation of Tiburon® Surgical Drapes delivers improved drapeability and additional cord management features.

Features and benefits of the next-generation Tiburon® Surgical Drape include:*

- AAMI Level 4 protection
- High-performance SMS material that customers know and trust
- Designed to stay in place throughout the procedure; avoids slippage
- Softer fabric for enhanced drapeability
- Velcro® Tabs for cord management on select codes
- Fabric anesthesia screen on select codes



Enhanced by technology

- We're pleased to bring to the market surgical drapes with proven SMS fabric that continue to deliver protection and performance.



Improved by you

- You asked for a more drapeable fabric; we listened.
- You asked for better cord management; we delivered.
- Your feedback helped us develop the next-generation Tiburon® Surgical Drapes.

AAMI Levels determined per ANSI/AAMI PB70:2012



Tiburon® Surgical Drapes and Packs

Ancillary

Tiburon® Surgical Drapes and Packs

Ancillary Patient Drapes



Ancillary

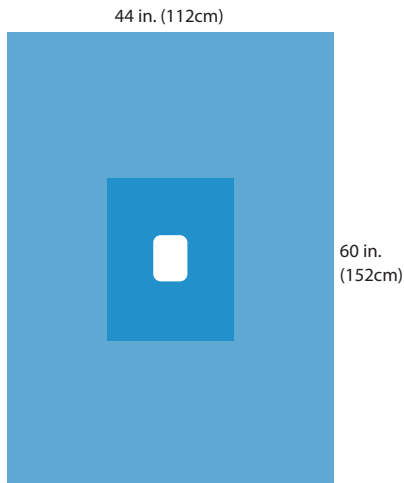
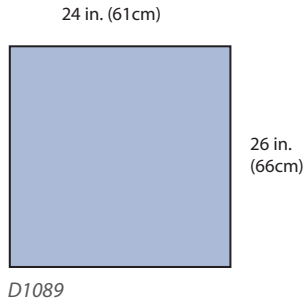
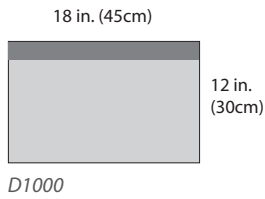

9462 Tiburon™ Utility Drape Sheet

Drape Towels

Sterile No.	Nonsterile No.	Description	Qty. Cs
D1000	D1000NS	Towel drape 18 x 12 in. (45 x 30cm), Adhesive 18 x 1.5 in. (45 x 3.8cm)	10
D1010	D1010NS	Towel drape 18 x 24 in. (45 x 61cm), Adhesive 18 x 1.5 in. (45 x 3.8cm)	10
D1089	D1089NS	Utility drape (2 drapes per pkg) 24 x 26 in. (61 x 66cm)	20 pkgs/cs

Drape Sheets

Sterile No.	Nonsterile No.	Description	Qty. Cs
9358	9358N	Tiburon® Half Sheet, 40 x 57 in. (101 x 145cm)	20
9355	9355N	Tiburon® Medium Sheet, 40 x 71 in. (101 x 180cm)	20
9349	9349N	Tiburon® Three-Quarter Sheet, 52 x 76 in. (132 x 193cm)	20
9446	9446N	Tiburon® Large Sheet, 72 x 85 in. (183 x 216cm)	30
9444	9444N	Tiburon® X-Large Sheet, 77 x 98 in. (195 x 249cm)	12
9462	9462N	Tiburon® Utility Drape Sheet, 44 x 60 in. (112 x 152cm), 4 x 6 in. (10 x 15cm) poly-reinforced fenestration	20



Tiburon® Surgical Drapes and Packs

Ancillary Patient Drapes

Ancillary

Drape Sheet, Square-Folded

Sterile No.	Nonsterile No.	Description	Qty. Cs
9461	9461N	Tiburon® Drape Sheet, square-folded, 38.5 x 38.5 in. (98 x 98cm)	30

Under-Buttocks Drapes

Sterile No.	Nonsterile No.	Description	Qty. Cs
8482	8482N	Under-buttocks drape, with fluid control pouch, filtering screen, drainage port and reinforcement	20
8483	8483N	Under-buttocks drape, reinforced poly, 9 in. cuff, 36 x 49 in. (91 x 125cm)	40
8484	8484N	Under-buttocks drape with fluid control pouch, reinforcement	20
8487	8487N	Under-buttocks drape with graduations, fluid control pouch with filtering screen and drainage port, plastic backing	20

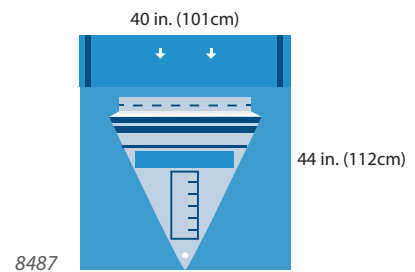
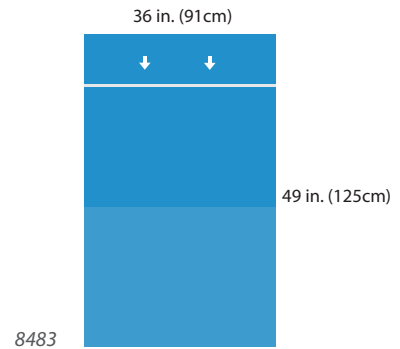
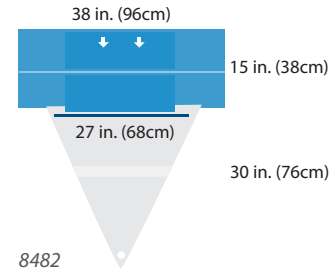

Tiburon® Surgical Drapes and Packs

Ancillary Patient Drapes

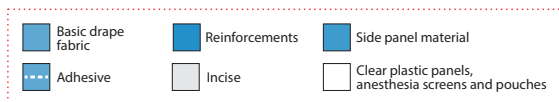

Ancillary

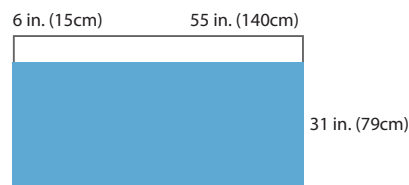

8430

Leggings

Sterile No.	Nonsterile No.	Description	Qty. Cs
8420	8420NA	Leggings, folded, 6 in. cuff, 28 x 43 in. (71 x 109cm), 2/pkg.	20
8430	8430NA	Clear leggings, folded, 6 in. cuff, 31 x 55 in. (79 x 140cm), 2/pkg	20

Stockinettes

Sterile No.	Nonsterile No.	Description	Size	Qty. Cs
1584	N/A	Stockinette, small	6 x 30 in. (15 x 76cm)	30
1585	1585N	Stockinette, medium	8 x 38 in. (20 x 96cm)	30
1586	1586N	Stockinette, large	9 x 48 in. (23 x 122cm)	40
1587	1582N	Stockinette, X-large	12 x 48 in. (31 x 122cm)	40

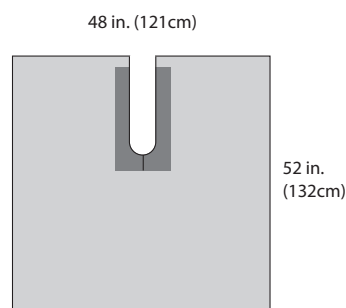

D1015

Poly U-Drapes

Sterile No.	Nonsterile No.	Description	Size	Qty. Cs
8475	8475N	Blue poly U-drape, 8 x 30 in. split with adhesive	60 x 84 in. (152 x 213cm)	22
8476	8476NA	Blue poly U-drape, 6 x 21 in. split with adhesive	60 x 72 in. (152 x 183cm)	24
D1015	D1015NS	Clear poly U-drape, Adhesive 9.5 x 19.5 in. (24 x 50cm), split 6 x 19 in. (15 x 48cm)	48 x 52 in. (121 x 132cm)	10
D1019	D1019NS	Clear poly U-drape, Adhesive 9.5 x 19.5 in. (24 x 50cm), Adhesive tab 3 x 1 in. (7 x 2.5cm), split 6 x 19 in. (15 x 48cm)	48 x 71 in. (121 x 180cm)	10

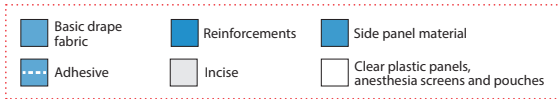

Tiburon® Surgical Drapes and Packs Drape Accessories

Ancillary

Adhesives and Drape Tape

Sterile No.	Nonsterile No.	Description	Qty. Cs
3524	N/A	Drape tape, 4 x 18.5 in. (10 x 47cm)	2

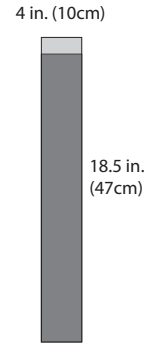

3524

Pouches

Sterile No.	Nonsterile No.	Description	Qty. Cs
D1016	D1016NS	Instrument pouch 6.75 x 11.5 in. (17 x 29cm), Adhesive (2) 6.75 x 2 in. (17 x 5cm)	10
D1018L	D1018LNS	Instrument pouch 10 x 18 in. (26 x 45cm), Adhesive (2) 10 x 2 in. (26 x 5cm)	10

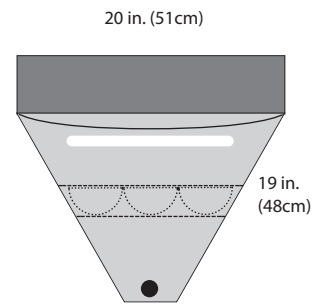

D1016

Pouches

Sterile No.	Nonsterile No.	Description	Qty. Cs
D1018	D1018NS	Fluid pouch 20 x 19 in. (51 x 48cm), Adhesive 20 x 3.75 in. (50 x 9cm)	10
D1072	D1072NS	Aperture pouch 18 x 9 in. (45 x 22cm), Aperture 4.75 x 3.75 in. (12 x 9cm), Adhesive (9.5 x 9 in.)	10

* Denotes a 6-8 week lead time

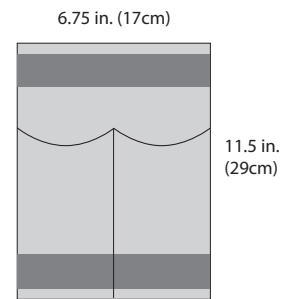

D1018

Isolation Bags

Sterile No.	Nonsterile No.	Description	Qty. Cs
D1003	D1003NS	Isolation bag 20 x 20 in. (51 x 51cm)	10

Equipment Drapes and Covers

Ancillary

Standard Back Tables Covers

Sterile No.	Nonsterile No.	Description	Qty. Cs
8376	8145N	Standard back table cover, 44 x 75 in. (112 x 190cm), SMS reinforcement, 23 x 75 in. (58 x 190cm)	22
8377	8146N	Standard back table cover, 44 x 90 in. (112 x 228cm), SMS reinforcement, 23 x 90 in. (58 x 228cm)	22
8378	8184N	Standard back table cover, 50 x 90 in. (127 x 228cm), SMS reinforcement, 29 x 90 in. (73 x 228cm)	24

Heavy-Duty Back Table Covers

Sterile No.	Nonsterile No.	Description	Qty. Cs
8186	8186N	Heavy-duty back table cover, 60 x 90 in. (152 x 229cm), thick SMS reinforcement, 29 x 90 in. (74 x 229cm)	24

Mayo Stand Covers

Sterile No.	Nonsterile No.	Description	Qty. Cs
8337	8337N	Mayo stand cover, reinforced poly, 23 x 55 in. (58 x 140cm)	30
8339	8339NI	Mayo stand cover, reinforced poly, 29.5 x 55 in. (75 x 140cm)	22

Equipment Covers

Sterile No.	Nonsterile No.	Description	Qty. Cs
D1012	D1012NS	Fluoroscope Cover 36 x 44 in. (91 x 111cm), Adhesive strips 36 x 0.5 in. (91 x 1.2cm), Adhesive tabs 2.5 x 4.25 in. (6 x 11cm)	10
D2158	D2158NS	Instrument Cover 24 x 18 in. (60 x 45cm), Adhesive 24 x 0.5 in. (60 x 1.2cm)	10
D2008A	D2008NS	Clear Cover 44 x 72 in. (111 x 182cm)	25

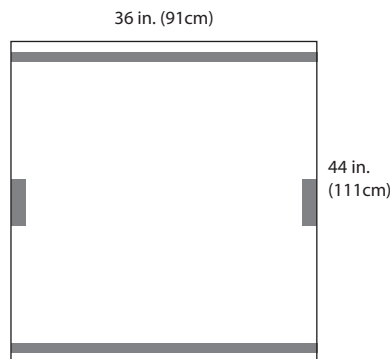

D1012

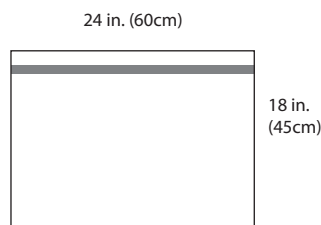

D2158

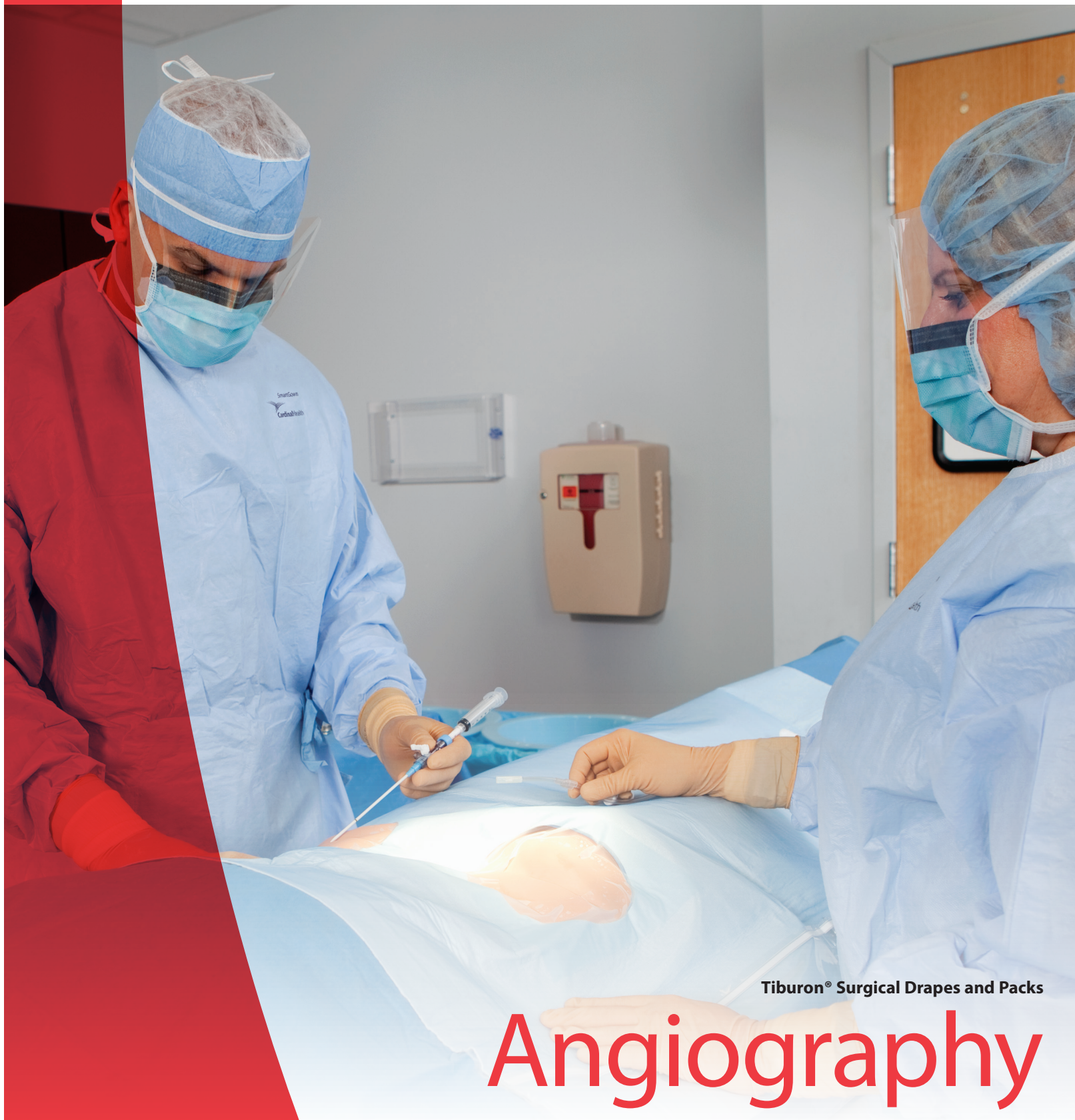

Tiburon® Surgical Drapes and Packs

Angiography

Tiburon® Surgical Drapes and Packs

Angiography

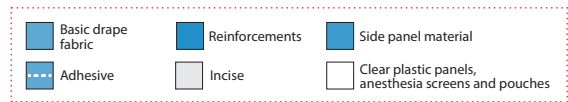

Angiography

Tiburon® Femoral Angiography Drape

Sterile No.	Nonsterile No.	Qty. Cs
29460	29460N	16

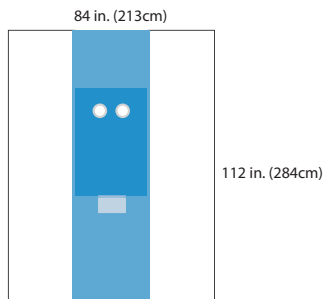

- Absorbent reinforcement, 28.75 x 44 in. (73 x 112cm)
- Catheter pouch, 8.5 x 11.5 in. (21 x 29cm)
- Clear side panels, 27.5 x 112 in. (70 x 285cm)
- Fenestration, dual circular, 6 in. (15cm), with circular incise aperture, 3.5 in. (9cm)

Extra Large Femoral Angiography Drape

Sterile No.	Nonsterile No.	Qty. Cs
29570	29570N	8

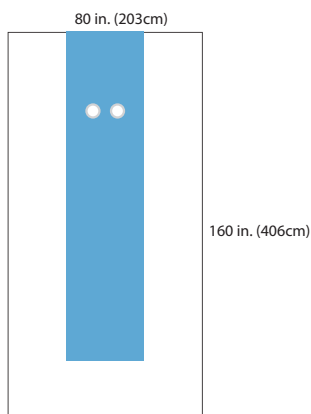

- Absorbent reinforcement, 33.5 x 135 in. (85 x 343cm)
- Clear foot panel, 80 x 25 in. (203 x 63.5cm)
- Clear side panels, 23.25 x 135 in. (60 x 343cm)
- Fenestration, dual circular, 6 in. (15cm), with circular incise aperture, 3.5 in. (9cm)

Tiburon® Femoral Angiography Drape

Sterile No.	Nonsterile No.	Qty. Cs
29456	29456N	14

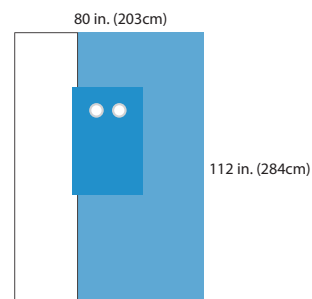

- Absorbent reinforcement, 29 x 44 in. (74 x 112cm)
- Fenestration, dual circular, 6 in. (15cm), with circular incise aperture, 3.5 in. (9cm)
- Single clear side panel on patient's right side, 26.5 x 112 in. (67 x 284cm)

Angiography Sheet

Sterile No.	Nonsterile No.	Qty. Cs
D2244	D2244NS	20

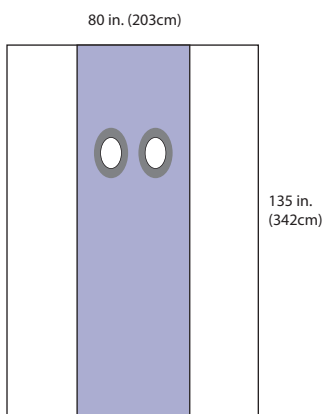

- Apertures: 3.5 x 4.5 in. (9 x 11cm)

Angiography Sheet

Sterile No.	Nonsterile No.	Qty. Cs
D1195	D1195NS	20

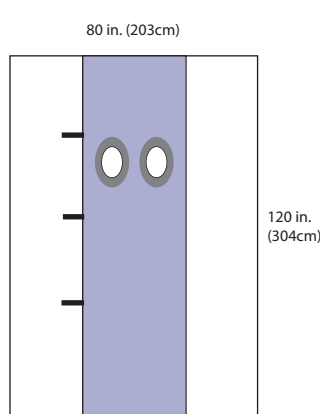

- Apertures: 3.5 x 4.5 in. (9 x 11cm)
- Moldable strips on right panel

Radial/Femoral Angiography Drape

Sterile No.	Nonsterile No.	Qty. Cs
29529	29529N	12

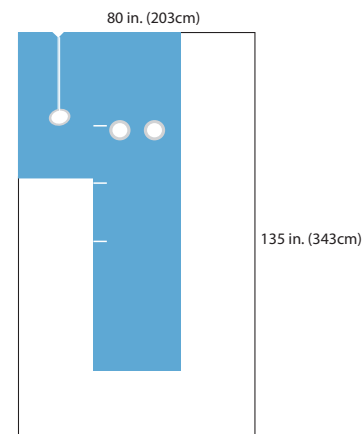

- Absorbent reinforcement
- Clear side and foot panels
- Fenestration, dual circular, 6 in. (15cm), with circular incise aperture, 3.5 in. (9cm)
- Malleable bars
- Radial access on patient right, 2 x 3 in. (5 x 7.5cm) oval incise aperture

Tiburon® Surgical Drapes and Packs
Angiography

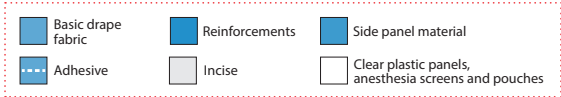

**Tiburon® Brachial Angiography
 Drape**

Sterile No.	Nonsterile No.	Qty. Cs
29458	29458N	40

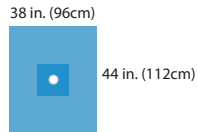

- Absorbent reinforcement, 12 x 12 in. (30 x 30cm)
- Fenestration, circular incise aperture, 4 in. (10cm)

Angiography



Tiburon® Surgical Drapes and Packs

Cardiovascular

Tiburon® Surgical Drapes and Packs

Cardiovascular

Tiburon® Cardiovascular Split Drape with Pouches

Sterile No.	Nonsterile No.	Qty. Cs
9155	9155N	12

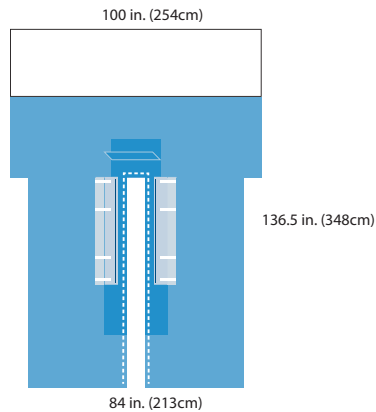

- Absorbent reinforcement, 10 x 57.5 in. (25.4 x 146cm) (sides) and 20 x 15 in. (51 x 38cm) (top)
- Armboard covers
- Clear anesthesia screen, 100 x 28.5 in. (254 x 72cm)
- Clear pouches on patient right and left
- Clipping tab
- Split with adhesive, 7 x 81 in. (18 x 206cm)

Tiburon® Cardiovascular Incise Drape

Sterile No.	Nonsterile No.	Qty. Cs
9156	9156N	7

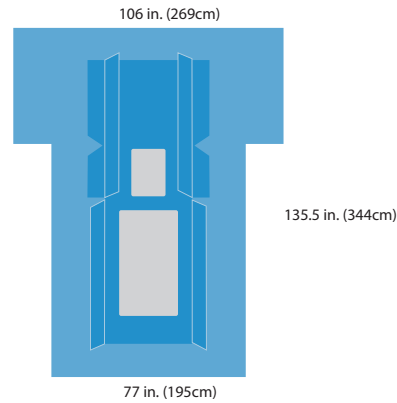

- Non-absorbent reinforcement
- Armboard covers
- Clipping tabs
- Fenestration, chest incise, 18 x 22 in. (46 x 56cm)
- Fenestration, leg incise, 28 x 45 in. (71 x 114cm)

Tiburon® Cardiovascular Split Drape

Sterile No.	Nonsterile No.	Qty. Cs
29154	29154N	8

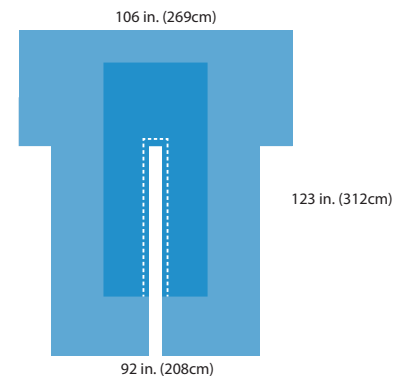

- Absorbent reinforcement
- Armboard covers
- Split with adhesive, 5 x 80 in. (13 x 203cm)

Tiburon® Cardiovascular Peri-Groin Drape

Sterile No.	Nonsterile No.	Qty. Cs
9154	9154N	10

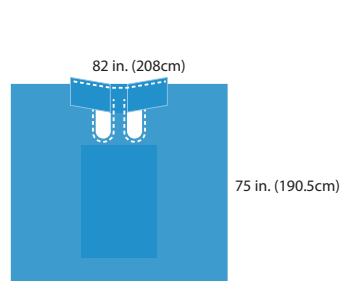

- Absorbent reinforcement, 30 x 42 in. (76 x 106cm)
- Attached groin sheet, 36 x 11 in. (91 x 28cm)
- Splits, dual with adhesive, 6 x 20 in. (15 x 51cm)
- Included in pack 29158

Tiburon® Cardiovascular Incise Drape

Sterile No.	Nonsterile No.	Qty. Cs
9162	9162N	7

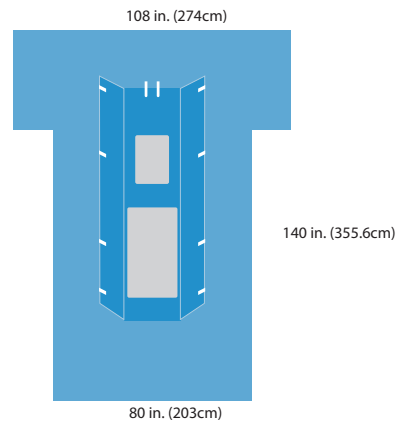

- Absorbent reinforcement, 42 x 88 in. (107 x 223cm)
- Armboard covers
- Fenestration, chest incise, 14 x 18 in. (25.5 x 46cm)
- Fenestration, leg incise, 24 x 41 in. (61 x 104cm)
- Instrument troughs, 8 x 88 in. (20 x 223cm)
- Velcro® Tabs

Tiburon® Surgical Drapes and Packs

Cardiovascular

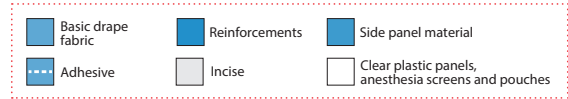

Tiburon® Head, Side and Foot Drapes

Sterile No.	Nonsterile No.	Qty. Cs
N/A	29462N	
N/A	29467N	
N/A	29468N	

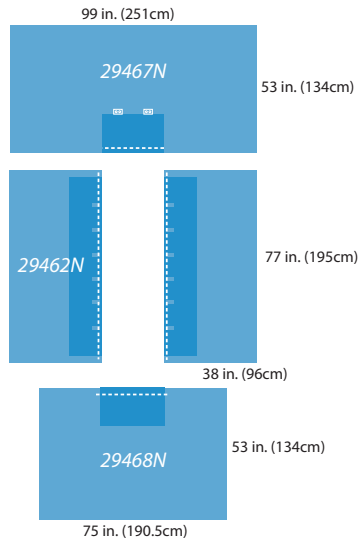

- Absorbent reinforcement
- Cord-holding tabs
- Included in pack 29153

Tiburon® Bottom Drape with Reinforcement

Sterile No.	Nonsterile No.	Qty. Cs
N/A	29464N	

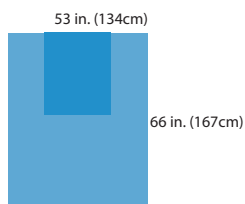

- Absorbent reinforcement, 26 x 30 in. (66 x 76cm)

Cardiovascular Packs

Nonsterile No.	Description	29153 Cardiovascular Pack with reinforced Gowns
9150N	Tiburon® Cardiovascular Drape	
29467N	Tiburon® Head Drape, 99 x 53 in. (251 x 134.6cm), adhesive, absorbent reinforcement	1
29462N	Tiburon® Side Drape, 38 x 77 in. (96 x 195cm), adhesive, absorbent reinforcement	2
29468N	Tiburon® Foot Sheet, 75 x 53 in. (190 x 134.6cm), adhesive, absorbent reinforcement	1
9349N	Tiburon® Three-Quarter Drape Sheet, 52 x 76 in. (132 x 193cm)	
9154N	Tiburon® Cardiovascular Peri-Groin Drape	
9158N	Tiburon® Cardiovascular Split Drape II	
29464N	Tiburon® Bottom Drape with reinforcement	1
9541N	Astound® Gown, sterile back, fabric reinforced, X-large	
9040N	Astound® Gown, poly reinforced, X-large	2
90780N	Astound® Gown, reinforced, X-large, with towel in outer wrap	1
90680NA	Astound® Gown, reinforced, large, with towel in outer wrap	
8520N	Absorbent towel	1
7554N	Tiburon® Drape Towel, with adhesive strip, 19 x 30 in. (48 x 76cm)	
8694-60	Suture bag	1
8337N	Mayo stand cover, reinforced poly, 23 x 55 in. (58 x 140cm)	
8188N	Overhead table cover, 80 x 90 in. (203 x 228.6cm), reinforced poly with a 44 x 72 in. (112 x 183cm) fabric sterile field extension, SMS reinforcement, 40 x 90 in. (101.6 x 228.6cm)	1
8554N	Non-absorbent drape towel with adhesive strip, 15 x 26 in. (38 x 66cm)	6
9460N	Peri-towel	1
8470N	Plastic sheet, 50 x 59 in. (127 x 150cm)	1
8152N	Heavy-duty back table cover, 80 x 110 in. (203 x 279cm), SMS reinforcement, 37 x 110 in. (94 x 279cm)	
8143N	Standard back table cover, 50 x 90 in. (127 x 228.6cm), SMS reinforcement, 29 x 90 in. (73.6 x 228.6cm)	1
Quantity per case		3

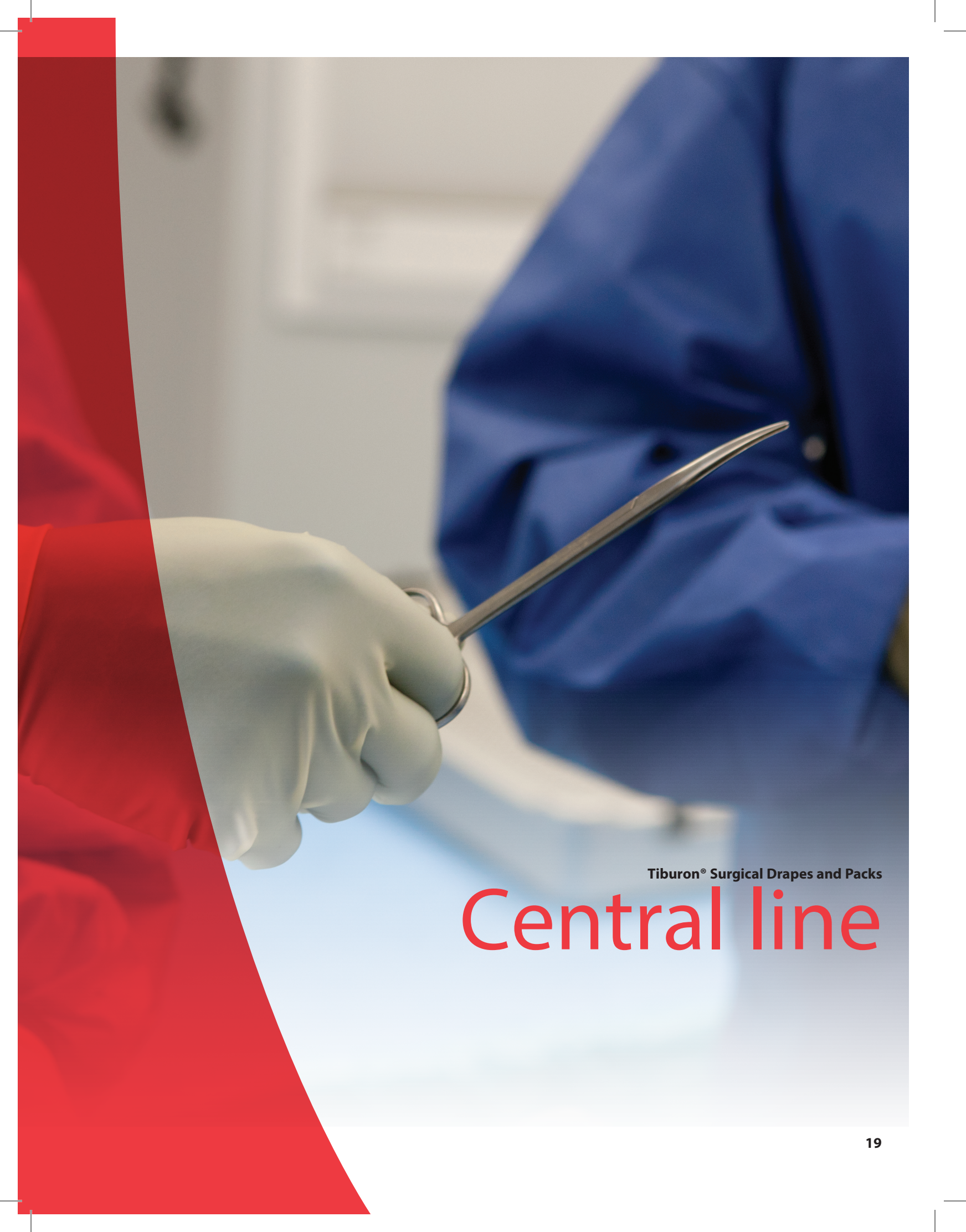

Tiburon® Surgical Drapes and Packs

Central line

Tiburon® Surgical Drapes and Packs

Central line

Full Body Central Line Insertion Drape

Sterile No.	Nonsterile No.	Qty. Cs
29322	29322N	10

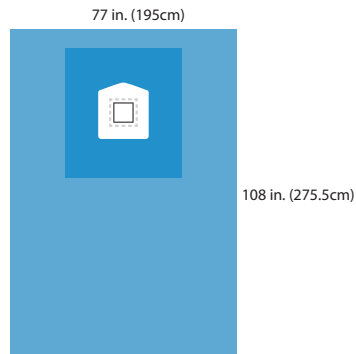

- Clear window, 18 x 18 in. (46 x 46cm)
- Fenestration with adhesive, 6 x 6 in. (15 x 15cm)
- Synthetic absorbent reinforcement, 41.5 x 41.5 in. (105 x 105cm)

Full Body Central Line Drape

Sterile No.	Nonsterile No.	Qty. Cs
29527	29527N	14

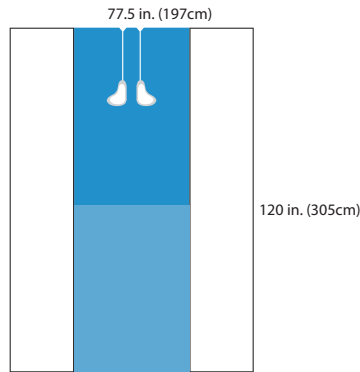

- Absorbent reinforcement, 36 x 57.5 in. (91 x 146cm)
- Fenestrations with incise aperture allow for intrajugular or subclavian access
- Clear side panels, 20.75 x 120 in. (53 x 305cm)
- Easy removal feature on both fenestrations

Central line

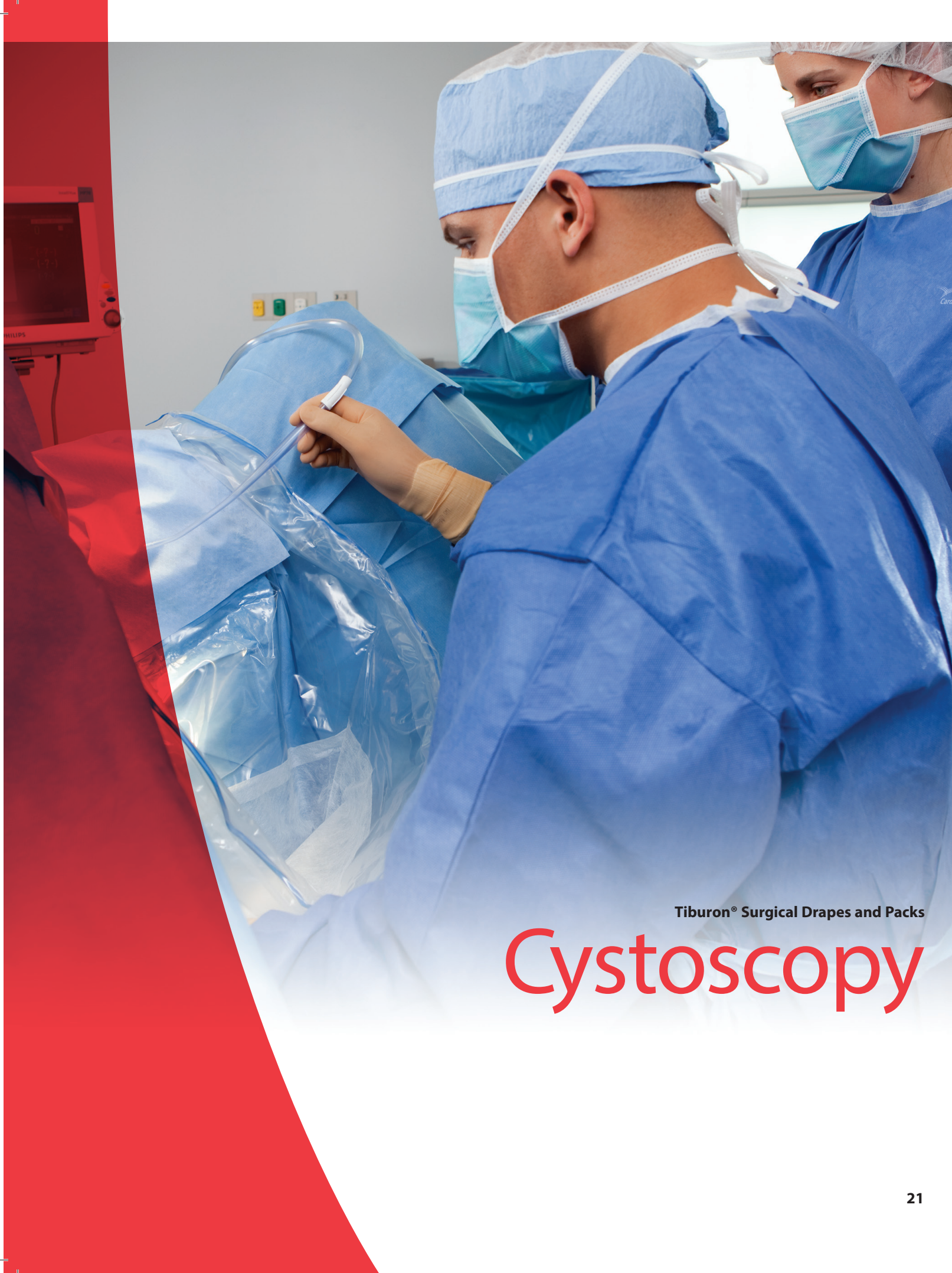

Tiburon® Surgical Drapes and Packs

Cystoscopy

Tiburon® Surgical Drapes and Packs

Cystoscopy



Cystoscopy

Tiburon® Cystoscopy "T" Drape

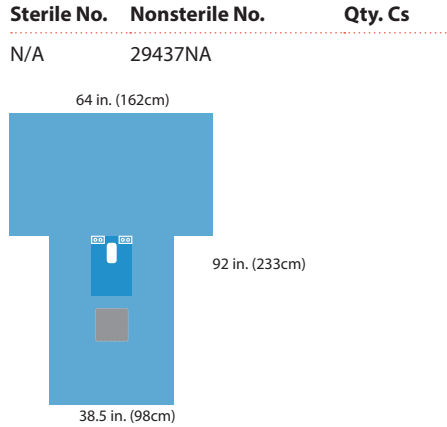

- Absorbent reinforcement, 12 x 21 in. (30.5 x 53cm)
- Cord-holding tabs
- Fenestration, 3 x 6 in. (7.5 x 15cm)
- Mesh screen, 10 x 10 in. (25 x 25cm)
- Included in packs 29470, 29471, 29480

Tiburon® Urological Drape

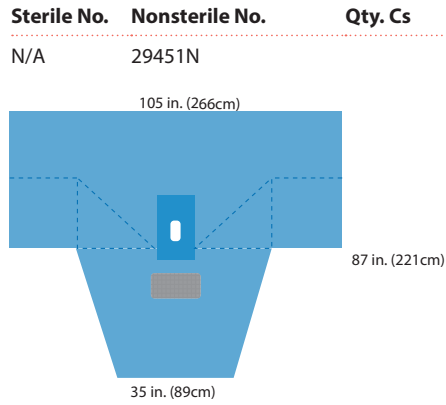

- Absorbent reinforcement, 12 x 19 in. (30.5 x 48cm)
- Attached leggings
- Cord-holding tabs
- Fenestration, 3 x 6 in. (7.5 x 15cm)
- Mesh screen, 14 x 8 in. (35.5 x 20cm)
- Included in pack 29360

Tiburon® Lithotomy Drape with Fluid Control Pouch

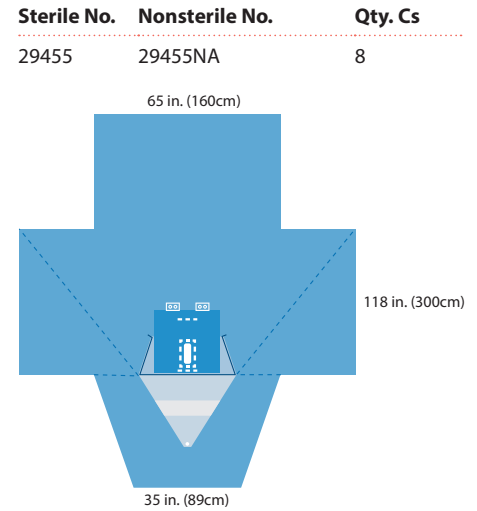

- Absorbent reinforcement, 20 x 19 in. (51 x 48cm)
- Anesthesia screen
- Attached leggings
- Cord-holding tabs
- Fenestration with adhesive, 2.5 x 6.5 in. (6 x 16.5cm)
- Fluid control pouch with filtering screen, suction port, drawstring feature and side trough
- Mesh screen, 20 x 6 in. (51 x 15cm)

Urological Drape

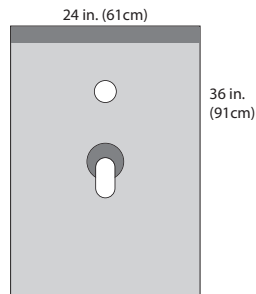

- Adhesive: 24 x 2.7 in. (61 x 7cm)
- Aperture: 1 in. dia. (2.5cm dia.)
- Finger Cot Adhesive: 4 in. dia. (10cm dia.)

Cystoscopy Packs

Nonsterile No.	Description	29480 Cystoscopy Pack	29360 Cystoscopy Pack
29437NA	Cysto in.T in. drape, absorbent reinforcement	1	
29451N	Urological drape with absorbent reinforcement, attached leggings		1
8694-60	Suture bag	1	1
8520N	Absorbent towel	1	1
8421N	Pair of leggings, X-large	1	
8145N	Outer wrap/reinforced poly table cover 44 x 75 in. (112 x 190cm), reinforcement 24 x 75 in. (61 x 190cm)	1	1
Quantity per case		14	10

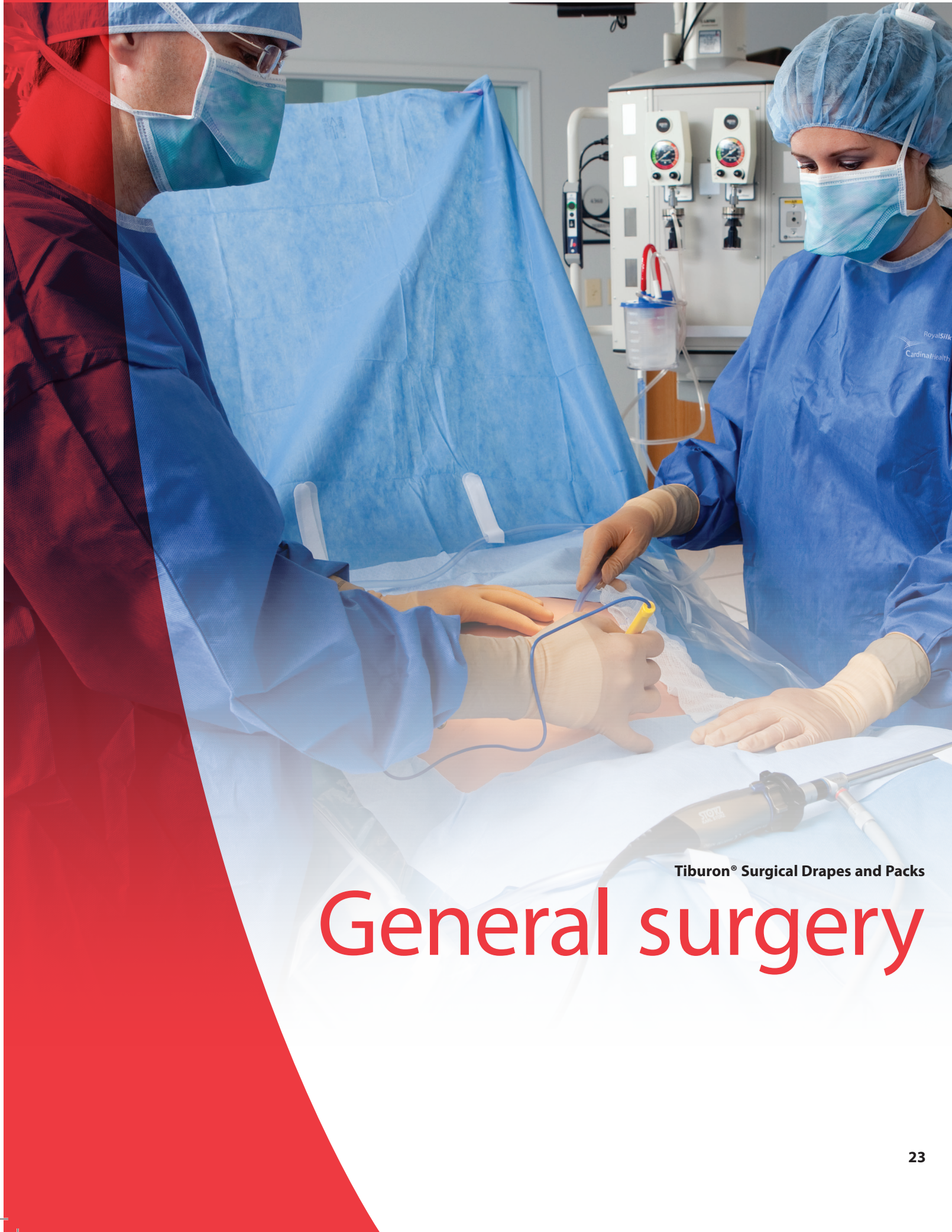

Tiburon® Surgical Drapes and Packs

General surgery

Tiburon® Surgical Drapes and Packs

General surgery

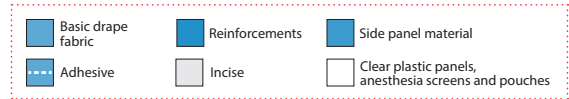

General surgery

Tiburon® Head, Side and Foot Drape

Sterile No.	Nonsterile No.
N/A	9467N
N/A	9465N
N/A	9468N

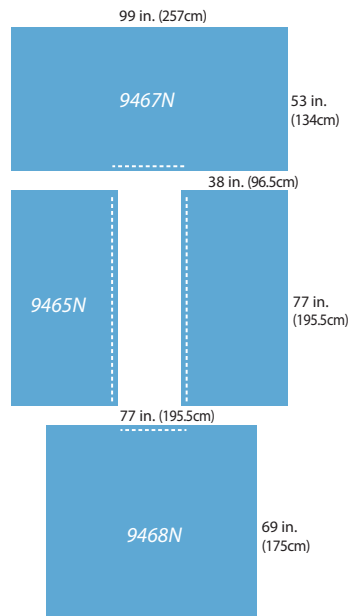

- Included in pack 9106

Tiburon® Universal Pack

Sterile No.	Nonsterile No.
N/A	29667N
N/A	29665N
N/A	29669N

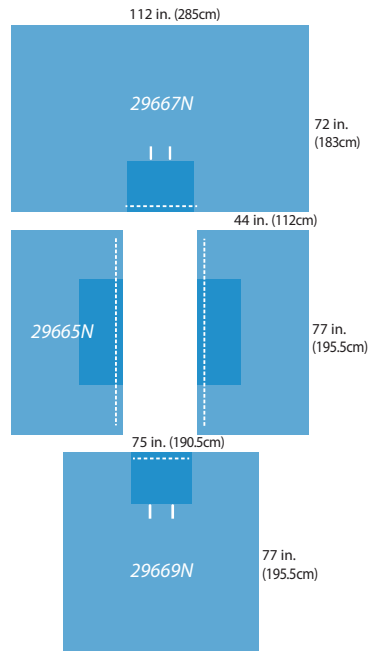

- Absorbent reinforcement with adhesive
- Cord-holding straps
- Included in pack 29118

Tiburon® Universal Split Pack

Sterile No.	Nonsterile No.	Qty. Cs
29352	29351N	14
29440	29440NA	10

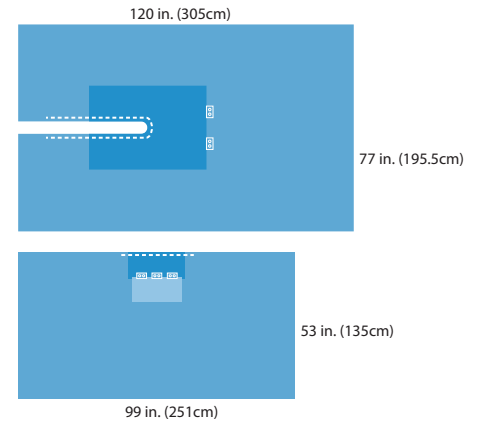

- Absorbent reinforcement
- Cord-holding tabs
- Split, 6 x 46 in. (15 x 117cm) (29440NA)
- Instrument pad (29351N)
- Included in pack 29131

Tiburon® Laparotomy Drape

Sterile No.	Nonsterile No.	Qty. Cs
29410	29410N	12

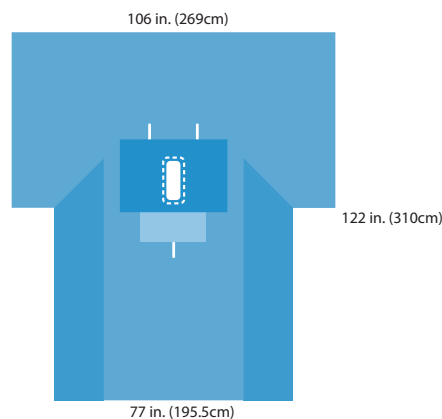

- Absorbent reinforcement, 30.5 x 24 in. (77.5 x 61cm)
- Armboard covers
- Velcro® Cord-Holding Tabs
- Fenestration, 4 x 12 in. (10 x 30.5cm)
- Instrument pad
- Included in packs 29136

Tiburon® Laparotomy Drape with Pouches

Sterile No.	Nonsterile No.	Qty. Cs
9430	9430N	12

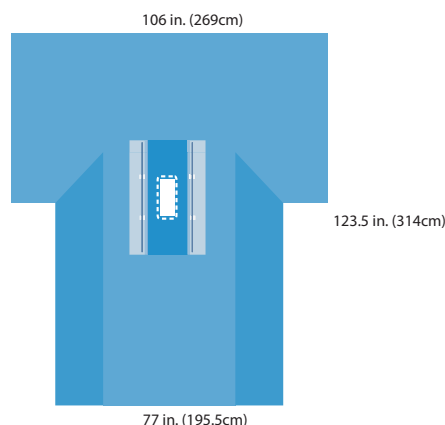

- Absorbent reinforcement, 14 x 38.5 in. (35.5 x 98cm)
- Armboard covers
- Dual clear closed end poly troughs with Velcro® Closures, 8 x 38.5 in (20 x 98cm)
- Fenestration, 4 x 12 in. (10 x 30.5cm)

Tiburon® Thyroid Drape

Sterile No.	Nonsterile No.	Qty. Cs
29422	29422N	10

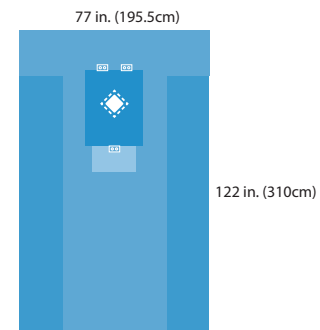

- Absorbent reinforcement, 22 x 30 in. (56 x 76cm)
- Cord-holding tabs
- Fenestration, diamond, 5 x 5 in. (13 x 13cm)
- Instrument pad

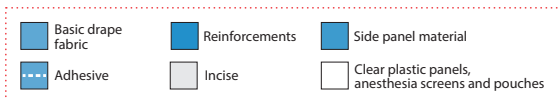

Tiburon® Surgical Drapes and Packs

General surgery

Tiburon® Chest/Breast Drape

Sterile No.	Nonsterile No.	Qty. Cs
29420	29420N	12

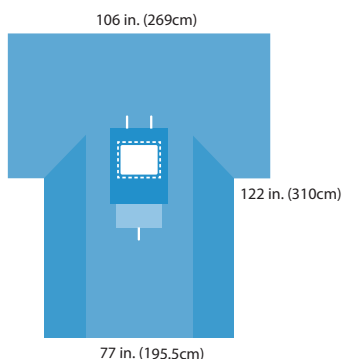

- Absorbent reinforcement, 22 x 30 in. (56 x 76cm)
- Armboard covers
- Velcro® Cord-Holding Tabs
- Fenestration, 14 x 11 in. (35.5 x 28cm)
- Instrument pad

Tiburon® Laparoscopic Cholecystectomy Drape with Pouches

Sterile No.	Nonsterile No.	Qty. Cs
9428	9428NA	8

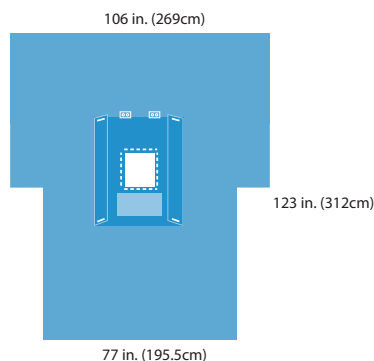

- Absorbent reinforcement, 36 x 42 in. (91 x 107cm)
- Armboard covers
- Cord-holding tabs
- Fabric pouches with adhesive, 10 x 42 in. (25 x 107cm)
- Fenestration, offset 5 in., 11 x 14 in. (12.7cm, 28 x 35.5cm)
- Instrument pad

Tiburon® General Endoscopy Drape

Sterile No.	Nonsterile No.	Qty. Cs
9458	9458N	12

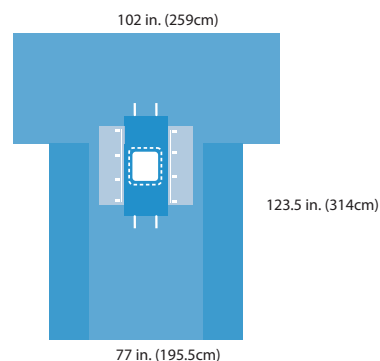

- Absorbent reinforcement, 16 x 38.5 in. (40.5 x 98cm)
- Armboard covers
- Dual clear open ended poly troughs with Velcro® Closure, 11.125 x 30 in. (28 x 76cm)
- Fenestration, 10 x 11 in. (25.5 x 28cm)
- Velcro® Cord-Holding Tabs

Tiburon® Bariatric Drape

Sterile No.	Nonsterile No.	Qty. Cs
94590	94590N	8

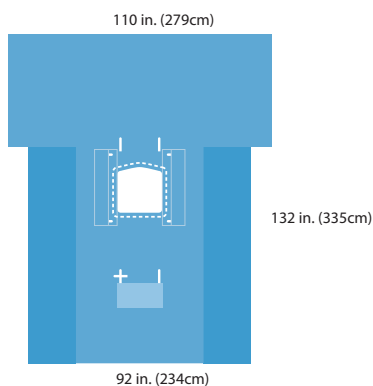

- Armboard covers
- Fabric instrument troughs, 28.5 x 24 in. (72 x 61cm)
- Fenestration, chevron, 18 x 18 in. (45.5 x 45.5cm)
- Instrument pad
- Velcro® Cord-Holding Tabs

Tiburon® Major Abdominal Drape with Pouches

Sterile No.	Nonsterile No.	Qty. Cs
9457	9457N	12

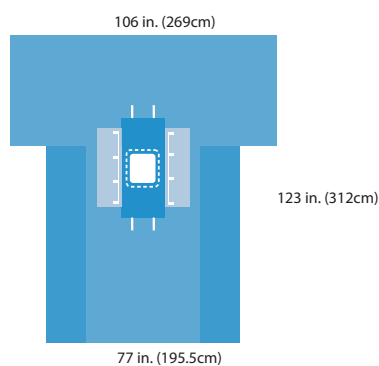

- Absorbent reinforcement, 16 x 38.5 in. (40.5 x 98cm)
- Armboard covers
- Dual clear pouches with Velcro® Closure, 11.125 x 30 in. (28 x 76cm)
- Fenestration, 10 x 11 in. (25.5 x 28cm)
- Velcro® Cord-Holding Tabs

General surgery

Tiburon® Surgical Drapes and Packs

General surgery

General surgery

Universal Packs

Nonsterile No.	Description	9106 Universal Pack	29118 Universal Pack	29131 Universal Split Pack
29440NA	Tiburon® Split Drape with absorbent reinforcement			1
29351N	Tiburon® Top Drape, absorbent reinforcement, instrument pad			1
29669N	Tiburon® Foot Drape, 75 x 77 in. (190.5 x 195.5cm), adhesive, absorbent reinforcement		1	
29667N	Tiburon® Head Drape, 112 x 72 in. (285 x 183cm), adhesive, absorbent reinforcement		1	
29665N	Tiburon® Side Drape, 44 x 77 in. (112 x 195.5cm), adhesive, absorbent reinforcement		2	
8520N	Absorbent towel	1	1	
8554N	Drape towel, adhesive, nonabsorbent		4	4
8337N	Mayo stand cover, reinforced poly, 23 in. (58cm) wide	1	1	1
8694-60	Suture bag	1	1	1
8146N	Outer wrap, reinforced poly table cover, 44 x 90 in. (112 x 228.6cm)	1	1	
8143N	Outer wrap, reinforced poly table cover, 50 x 90 in. (127 x 228.6cm)			1
Quantity per case		5	6	4

Laparotomy Packs

Nonsterile No.	Description	29136 Laparotomy Pack
9358N	Tiburon® Half Drape, 40 x 57 in. (101 x 145cm)	1
29410N	Tiburon® Laparotomy Drape, absorbent reinforcement	1
8554N	Drape towel, adhesive, nonabsorbent	4
8520N	Absorbent towel	1
8337N	Mayo stand cover, reinforced poly, 23 in. (58cm) wide	1
8694-60	Suture bag	1
8143N	Outer wrap, reinforced poly table cover, 50 x 90 in. (127 x 228.6cm)	1
Quantity per case		5



Tiburon® Surgical Drapes and Packs

Neurosurgery

Tiburon® Surgical Drapes and Packs

Neurosurgery



Neurosurgery

Tiburon® Neurological Drape

Sterile No.	Nonsterile No.	Qty. Cs
9448	9448N	8

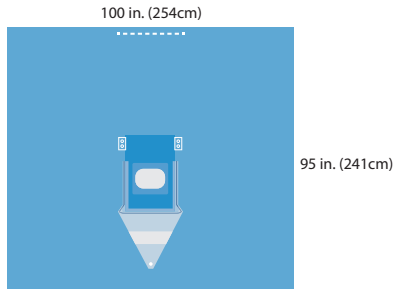

- Absorbent reinforcement, 18.5 x 28.5 in. (47 x 72cm)
- Cord-holding tabs
- Fenestration, oval with full incise, 11 x 7 in. (28 x 18cm)
- Fluid control drawstring pouch with screen and port, 20.5 x 40 in. (52 x 101.5cm)

Tiburon® Universal Spine Drape

Sterile No.	Nonsterile No.	Qty. Cs
29418	29418N	7

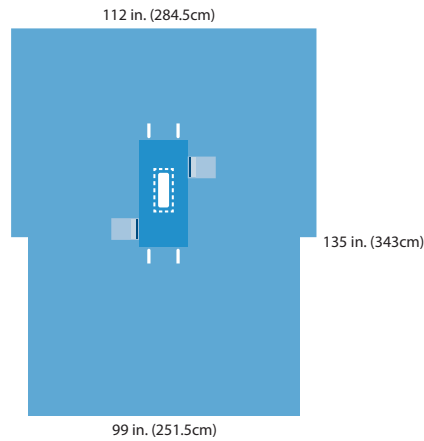

- Absorbent reinforcement, 20 x 37 in. (51 x 94cm)
- Armboard covers
- Fenestration, 4 x 12 in. (10 x 30.5cm)
- Instrument pouches, 7.5 x 12 in. (19 x 30.5cm)
- Velcro® Cord-Holding Tabs

Tiburon® Craniotomy Split Drape

Sterile No.	Nonsterile No.	Qty. Cs
9439	9439N	8

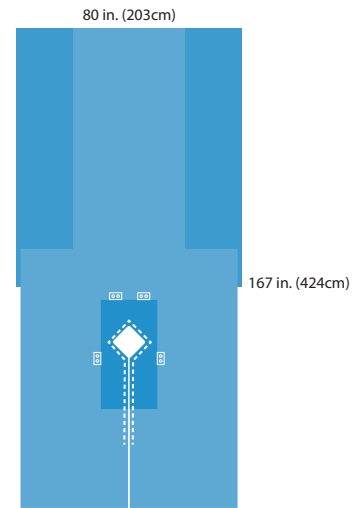

- Absorbent reinforcement, 20 x 38 in. (51 x 96.5cm)
- Attached overhead table cover, 80 x 90 in. (203 x 228.5cm)
- Cord-holding tabs
- Fenestration, diamond, 8 x 8 in. (20 x 20cm)
- Split, 54 in. (137cm)

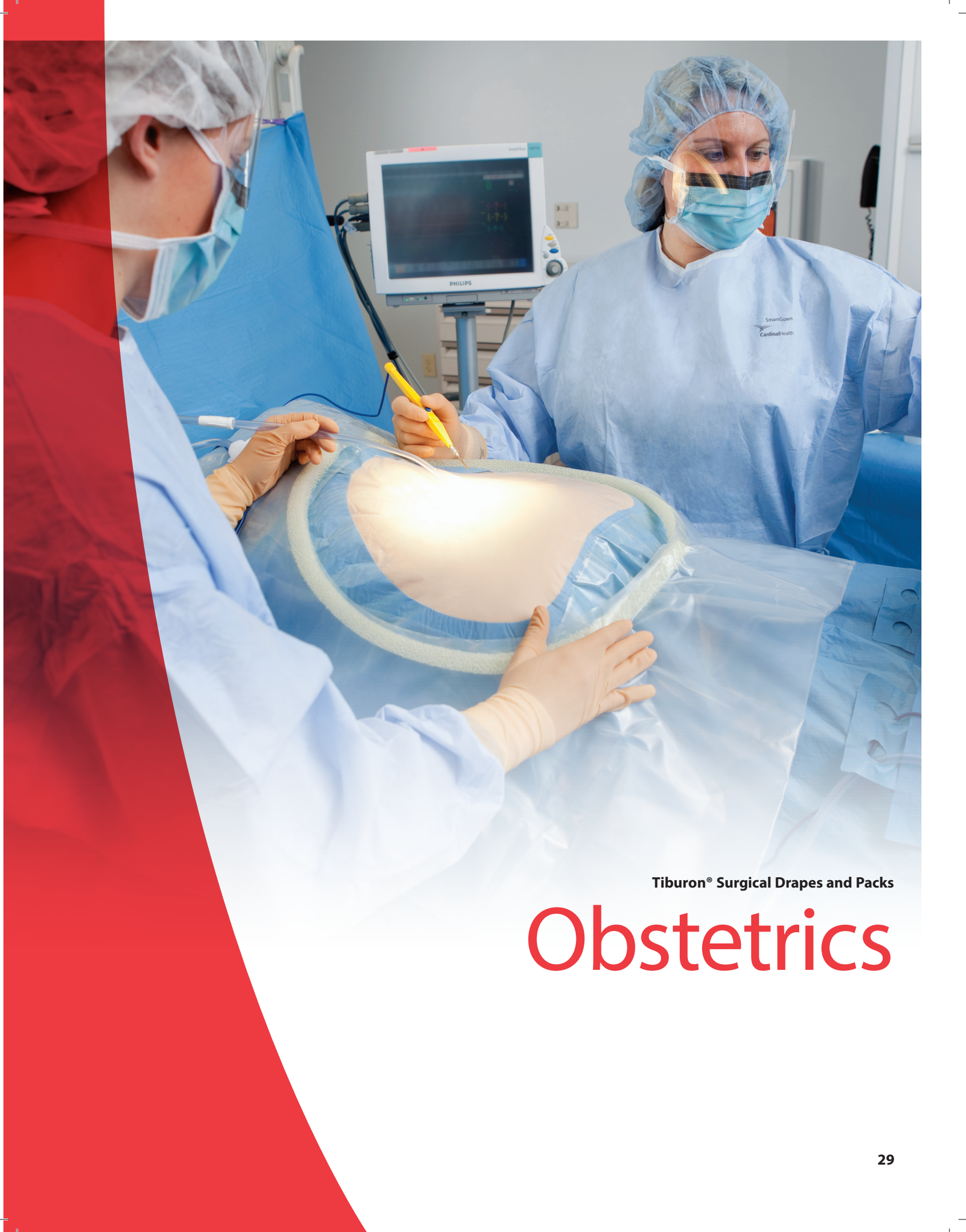

Tiburon® Surgical Drapes and Packs

Obstetrics

Tiburon® Surgical Drapes and Packs

Obstetrics



Obstetrics

Tiburon® Cesarean Birth Drape

Sterile No.	Nonsterile No.	Qty. Cs
29449	29449N	7

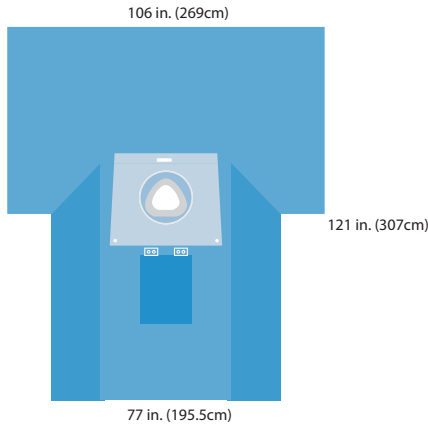

- 360-degree fluid control pouch with contoured foam ring, Velcro® Cord-Holding Tab and ports
- Armboard covers
- Fenestration, circular with 2 in. (5cm) incise aperture, 16 in. (40.5cm)
- Reinforcement, 17 x 22 in. (43 x 56cm)
- Cord-holding tabs

Tiburon® Cesarean Birth Drape

Sterile No.	Nonsterile No.	Qty. Cs
29443	29443N	7

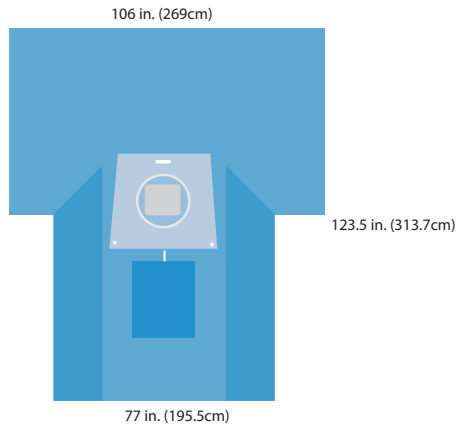

- 360-degree fluid control pouch with contoured foam ring, Velcro® Cord-Holding Tab and ports
- Armboard covers
- Fenestration, full incise, 9 x 14 in. (23 x 35.5cm)
- Reinforcement, 17 x 22 in. (43 x 56cm)
- Velcro® Cord-Holding Tabs

Tiburon® Cesarean Birth Drape

Sterile No.	Nonsterile No.	Qty. Cs
29448	29448N	7

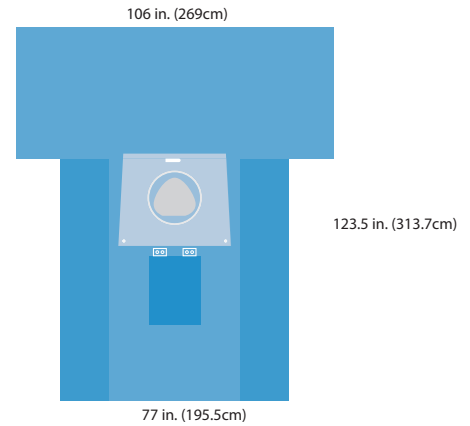

- 360-degree fluid control pouch with contoured foam ring, Velcro® Cord-Holding Tab and ports
- Armboard covers
- Cord-holding tabs
- Fenestration, pear-shaped with full incise, 12 x 14 in. (30.5 x 35.5cm)
- Reinforcement, 17 x 22 in. (43 x 56cm)

Tiburon® Cesarean Birth Drape

Sterile No.	Nonsterile No.	Qty. Cs
29452	29452N	8

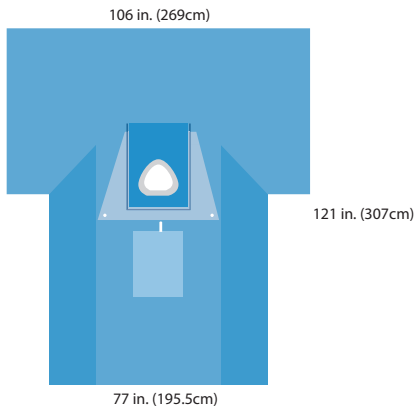

- 270-degree fluid control pouch with malleable wire
- Armboard covers
- Velcro® Cord-Holding Tabs
- Fenestration, pear-shaped with 2 in. (5cm) incise aperture, 12 x 14 in. (30.5 x 35.5cm)
- Reinforcement around fenestration (20.375 x 27 in. (51.8 x 68.6cm)) and below pouch (17 x 22 in. (43 x 56cm))

Tiburon® Cesarean Birth Drape

Sterile No.	Nonsterile No.	Qty. Cs
29447	29447N	8

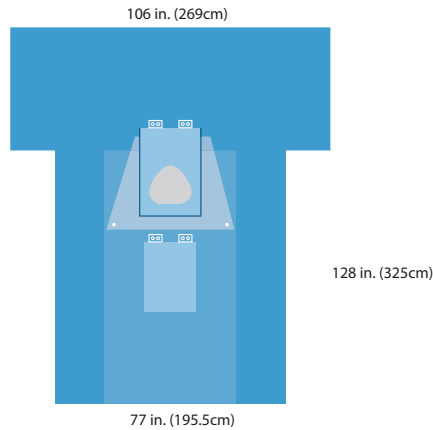

- 270-degree fluid control pouch with malleable wire and ports
- Armboard covers
- Cord-holding tabs
- Fenestration, pear-shaped with full incise, 12 x 14 in. (30.5 x 35.5cm)
- Reinforcement around fenestration (20.375 x 27 in. (51.8 x 68.6cm)) and below pouch (17 x 22 in. (43 x 56cm))

Tiburon® Abdominal Cover

Sterile No.	Nonsterile No.	Qty. Cs
N/A	29357N	

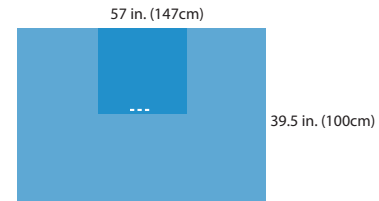

- Absorbent reinforcement, 19 x 19 in. (48 x 48cm)
- Included in pack 29920

Obstetrics

Obstetrics Pack

Nonsterile No.	Description	29920 Obstetrics Pack
29357N	Abdominal cover	1
8421N	Pair of leggings, X-large	1
8483N	Under-buttocks drape, reinforced poly	1
8365N	Setup cover, 44 x 71 in. (111.7 x 180cm)	1
8520N	Absorbent towel	2
8145N	Outer wrap/reinforced poly table cover 44 x 75 in. (111.7 x 190.5cm), reinforcement 24 x 75 in. (61 x 190.5cm)	1
	Quantity per case	6



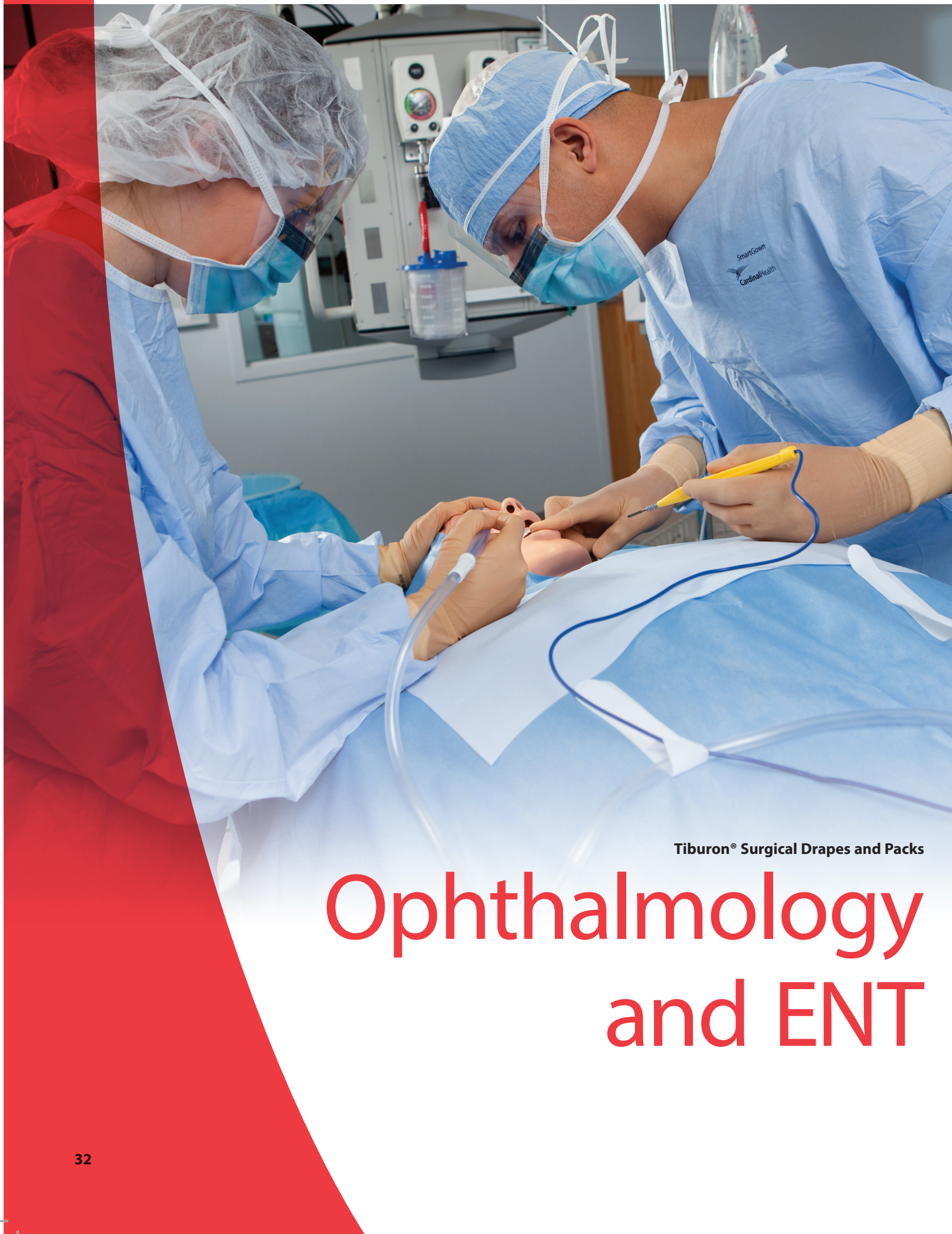

Tiburon® Surgical Drapes and Packs

Ophthalmology and ENT

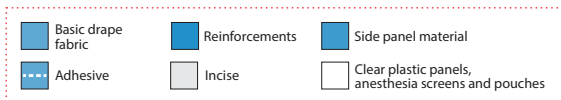

Tiburon® Surgical Drapes and Packs

Ophthalmology and ENT

Ophthalmology and ENT

Ophthalmic Drape

Sterile No.	Nonsterile No.	Qty. Cs
7444	7444N	10

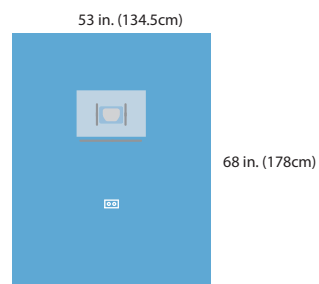

- Cord-holding tab
- Dual saddlebag fluid control pouches with malleable strips
- Full incise, 4 x 5 in. (10 x 13cm)
- Malleable breather-bar
- SMS material

Ophthalmic Drape

Sterile No.	Nonsterile No.	Qty. Cs
7445	7445N	10

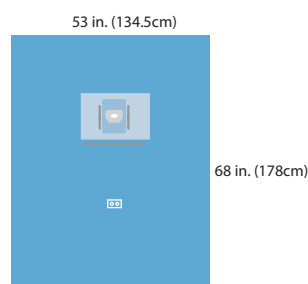

- Dual saddlebag fluid control pouches with malleable strips
- Malleable breather-bar
- Oval incise aperture, 1.5 x 2.5 in. (4 x 6cm)
- Cord-holding tab
- SMS material

Ophthalmic Drape with Pouch

Sterile No.	Nonsterile No.	Qty. Cs
9562	9562N	10

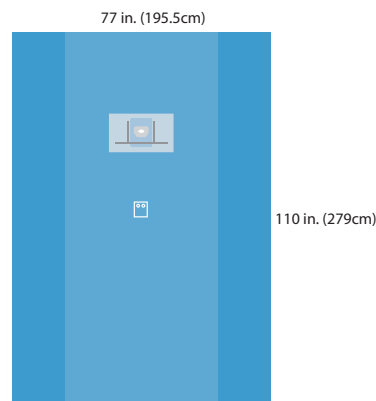

- Attached fluid control saddlebag pouch
- Cord-holding tab
- Malleable breathing bar
- Oval aperture with incise, 1.5 x 2.5 in. (4 x 6cm)
- Separate incise sheet, 5 x 4 in. (13 x 10cm)
- SMS material

Ophthalmic Incise Drape

Sterile No.	Nonsterile No.	Qty. Cs
D2258	N/A	10

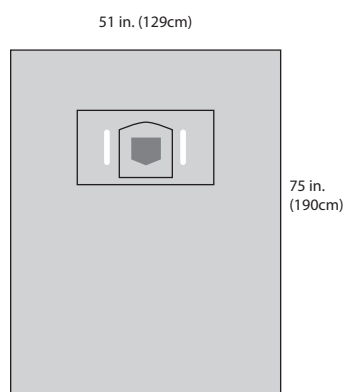

- Adhesive Area: 4.5 x 5 in. (11 x 12cm)
- Pouch: 21 x 11.5 in. (53 x 29cm)

Ophthalmic Aperture Drape

Sterile No.	Nonsterile No.	Qty. Cs
D1031	D1031NS	10

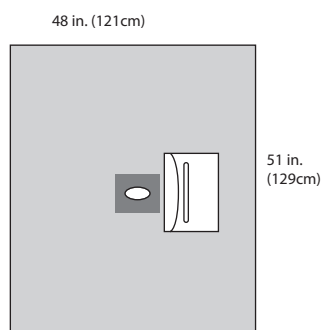

- Aperture: 3 x 2 in. (7 x 5cm)
- Pouch: 11 x 12 in. (28 x 30cm)

Small Drape with Adhesive Aperture

Sterile No.	Nonsterile No.	Qty. Cs
8441	8441N	40

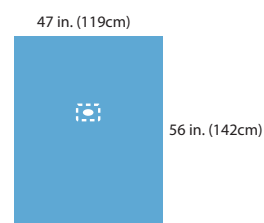

- Oval fenestration 2 x 3 in. (5 x 7.5cm)
- SMS material

Ophthalmology and ENT

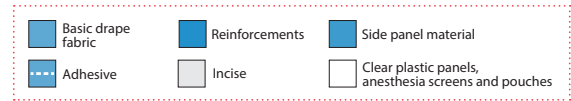

Ophthalmology and ENT

Ophthalmic Incise Drape

Sterile No.	Nonsterile No.	Qty. Cs
D1021	D1021NS	10

16 in. (40cm)

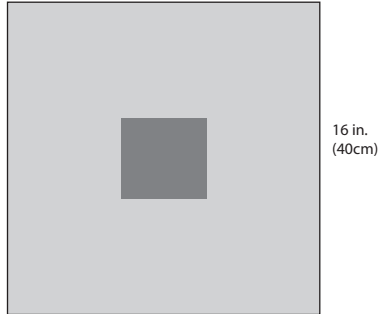

16 in.
(40cm)

- Adhesive Area: 5 x 4.25 in. (12 x 11cm)

Ophthalmic Incise Drape

Sterile No.	Nonsterile No.	Qty. Cs
D1061	D1061NS	10

48 in. (121cm)

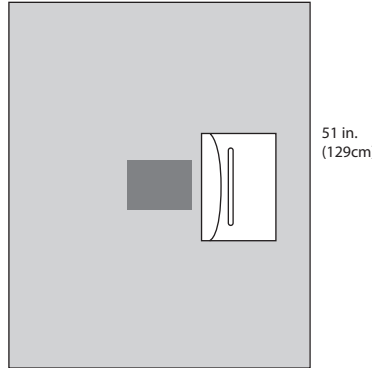

51 in.
(129cm)

- Adhesive Area: 5 x 4.25 in. (12 x 11cm)
- Pouch: 11 x 12 in. (28 x 30cm)

Ophthalmic Incise Pouch

Sterile No.	Nonsterile No.	Qty. Cs
D1025	D1025NS	10

19 in. (48cm)

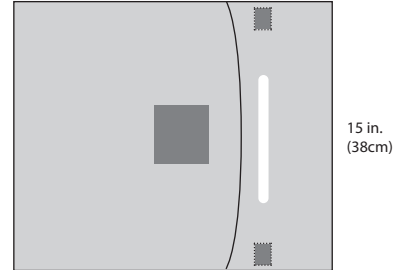

15 in.
(38cm)

- Adhesive Area: 5 x 4.25 in. (12 x 11cm)
- Adhesive Tabs: (2) 1 x 2 in. (2.5 x 5cm)

Ophthalmic Incise Drape

Sterile No.	Nonsterile No.	Qty. Cs
D1060	D1060NS	10

48 in. (121cm)

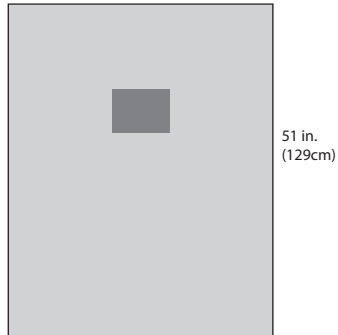

51 in.
(129cm)

- Adhesive Area: 5 x 4.25 in. (12 x 11cm)

Ophthalmic Incise Drape

Sterile No.	Nonsterile No.	Qty. Cs
D2019	D2019NS	30

42 in. (106cm)

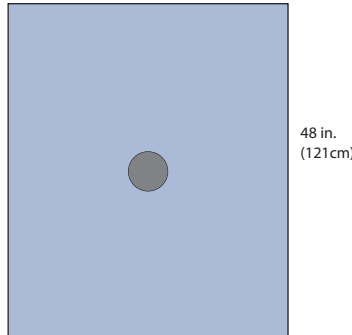

48 in.
(121cm)

- Adhesive Area: 3 in. dia. (7cm dia.)

Aperture Drape

Sterile No.	Nonsterile No.	Qty. Cs
D1020	D1020NS	10

16 in. (40cm)

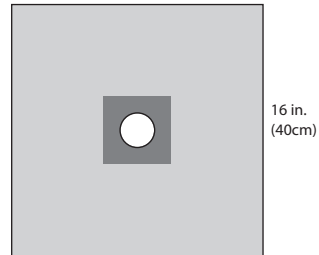

16 in.
(40cm)

- Aperture: 2.5 in. dia. (6cm dia.)



Tiburon® Surgical Drapes and Packs

Ophthalmology and ENT

Ophthalmology and ENT

Refractive Drape

Sterile No.	Nonsterile No.	Qty. Cs
D1122		10

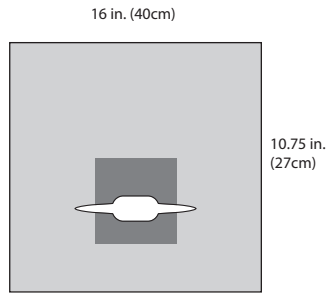

- Aperture: 1.5 x 1 in. (3.8 x 2.5cm)

Ophthalmic Aperture Drape

Sterile No.	Nonsterile No.	Qty. Cs
D1024	D1024NS	10

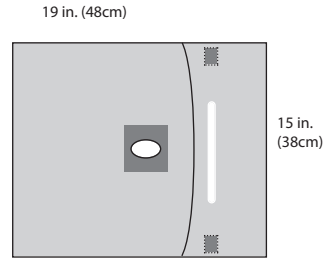

- Aperture: 2 x 1.5 in. (5cm x 4cm)
- Adhesive Tabs: (2) 1 x 2 in. (2.5 x 5cm)

Strabismus Drape

Sterile No.	Nonsterile No.	Qty. Cs
D2043	D2043NS	10

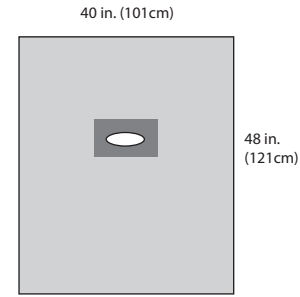

- Aperture: 5.2 x 1.5 in. (13 x 4cm)

Ophthalmic Aperture Drape

Sterile No.	Nonsterile No.	Qty. Cs
D2020	D2020NS	30

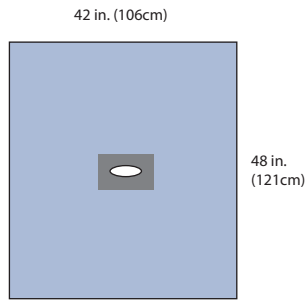

- Aperture: 3 x 2 in. (7 x 5cm)

Tiburon® ENT Split Drape

Sterile No.	Nonsterile No.	Qty. Cs
N/A	9443N	

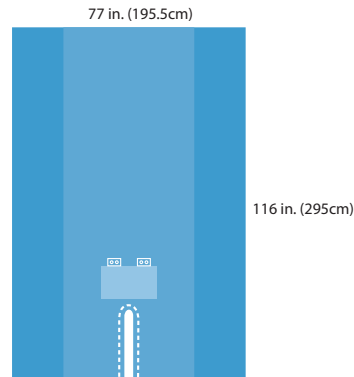

- Split with adhesive, 2.5 x 25 in. (6 x 63.5cm)
- Cord-holding tabs
- Instrument pad
- Included in pack 9195

Tiburon® Large ENT Split Drape

Sterile No.	Nonsterile No.	Qty. Cs
9447	9447N	8

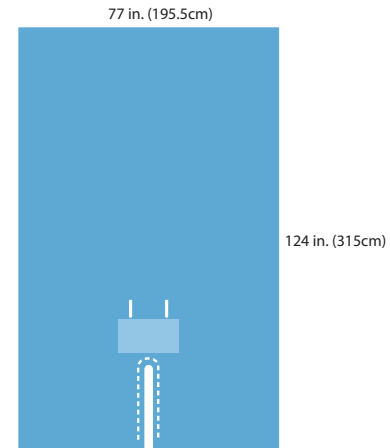

- Instrument pad
- Split with adhesive, 2.5 x 25 in. (6 x 63.5cm)
- Velcro® Cord-Holding Tabs
- Included in pack 9196

Tiburon® Surgical Drapes and Packs

Ophthalmology and ENT



Ophthalmology and ENT

Tiburon® Large ENT Split Drape

Sterile No.	Nonsterile No.	Qty. Cs
TB9441	9441N	8

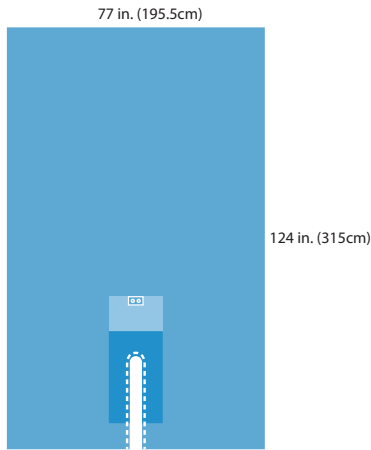

- Absorbent reinforcement, 15.25 x 28 in. (39 x 71cm)
- Cord-holding tabs
- Instrument pad, 15.25 x 9.5 in. (38 x 24cm)
- Split with adhesive, 3.5 x 28 in. (9 x 71cm)

Tiburon® Head/Bar Drape

Sterile No.	Nonsterile No.	Qty. Cs
9556	9556N	20

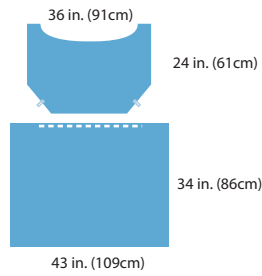

- Cord-holding tabs
- Turban
- Included in pack 9194

Tiburon® Bar Drape

Sterile No.	Nonsterile No.	Qty. Cs
N/A	9557N	

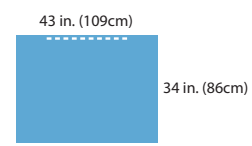

- Adhesive
- Included in pack 9195

Tiburon® Surgical Drapes and Packs
Ophthalmology and ENT

Head and Neck Packs

Nonsterile No.	Description	9195 Head and Neck Pack	9196 Head and Neck Pack
9556N	Tiburon® Head/Bar Drape, adhesive		1
9447N	Tiburon® Large ENT split drape		1
9557N	Tiburon® Bar Drape, adhesive	1	
9443N	Tiburon® Split Drape, unreinforced, adhesive	1	
90270NA	Astound® Standard Scrub Nurse Gown with towel in outer wrap, large		1
9515NA	Astound® Standard Gown, large	1	1
8554N	Drape towel, adhesive, nonabsorbent	2	2
8520N	Absorbent towel		1
8337N	Mayo stand cover, reinforced poly, 23 in. wide (58cm)	1	1
8694-60	Suture bag	1	1
8146N	Outer wrap, reinforced poly table cover, 44 x 90 in. (111.7 x 228.6cm)	1	1
	Quantity per case	8	6

Ophthalmology and ENT

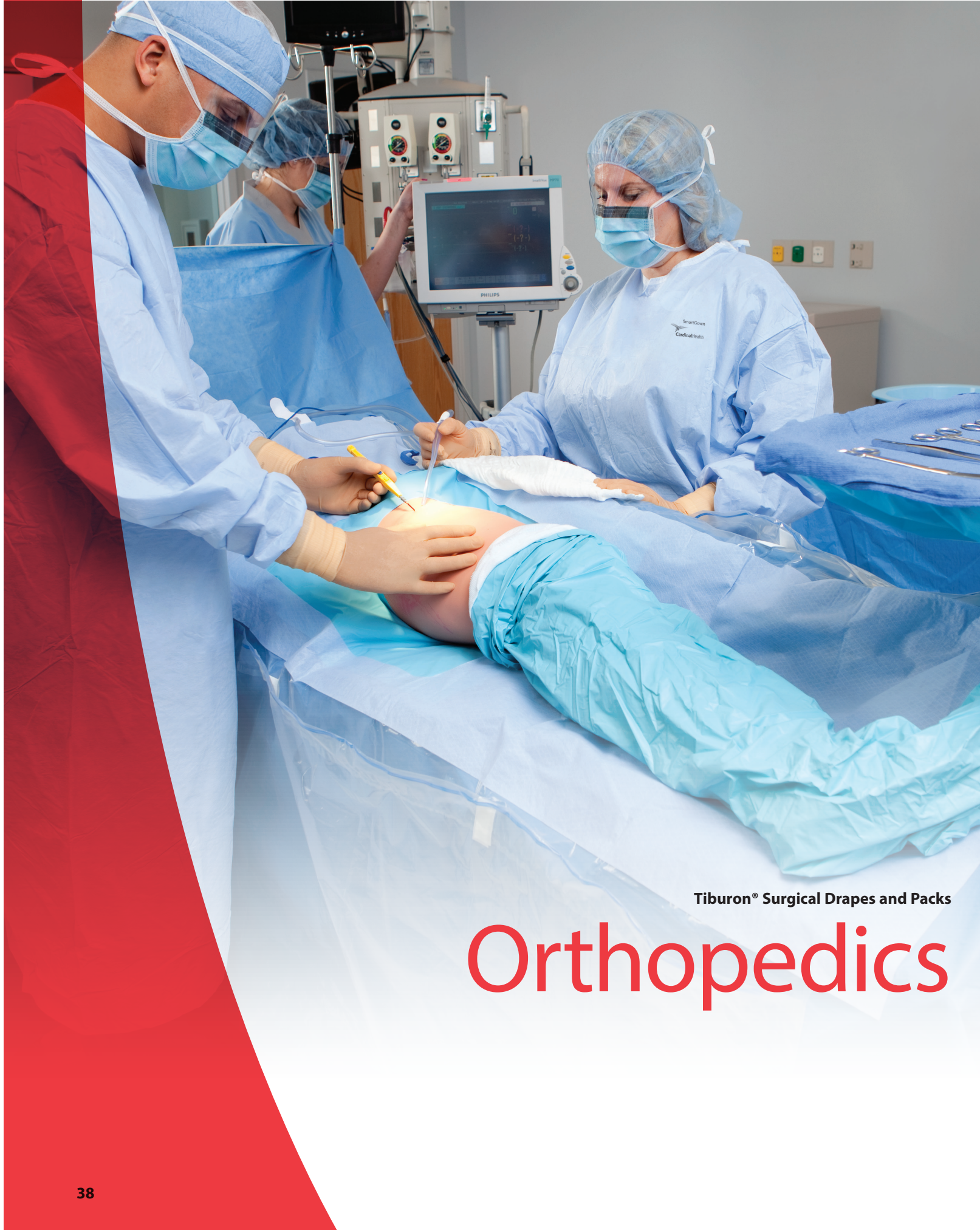

Tiburon® Surgical Drapes and Packs

Orthopedics



Tiburon® Surgical Drapes and Packs

Orthopedics - Heavy Duty

Tiburon® HD Extremity Drape

Sterile No.	Nonsterile No.	Qty. Cs
59405	59405N	6

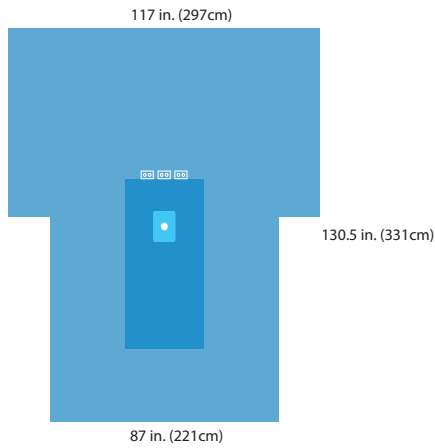

- Absorbent reinforcement, 30.5 x 55.5 in. (77.5 x 141cm)
- Anesthesia screen
- Armboard covers
- Cord-holding tabs
- Fenestration, circular elastic, 2.5 in. (6cm)
- Heavyweight, premium fabric
- Included in pack 59180

Tiburon® HD Arthroscopy Drape

Sterile No.	Nonsterile No.	Qty. Cs
59413	59413N	6

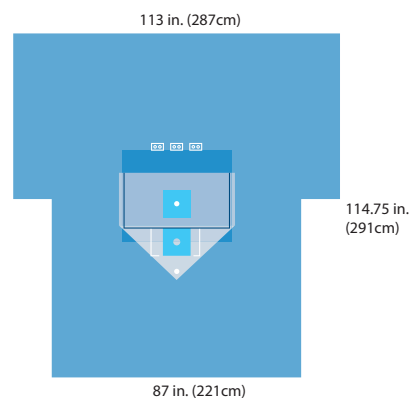

- Absorbent reinforcement
- Anesthesia screen
- Armboard covers
- Cord-holding tabs
- Dual fenestration, circular elastic, 2 in. (6cm)
- Fluid control pouch with malleable wire drawstring pouch and port
- Heavyweight, premium fabric
- Included in pack 9197

Tiburon® HD Hip Drape with Pouches

Sterile No.	Nonsterile No.	Qty. Cs
59439	59439N	4

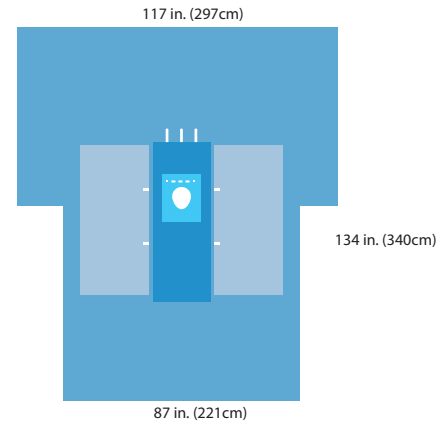

- Absorbent reinforcement, 21 x 57 in. (53 x 145cm)
- Anesthesia screen
- Armboard covers
- Heavyweight, premium fabric
- Clear leg positioning pouches, 54 x 30 in. (137 x 76cm)
- Fenestration, pear-shaped elastic, 6.75 x 8.25 in. (17 x 21cm)
- Velcro® Cord-Holding Tabs

Orthopedics - Heavy Duty

Tiburon® Surgical Drapes and Packs

Orthopedics

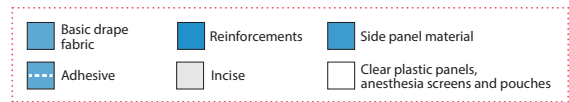

Orthopedics

Tiburon® Split Drape

Sterile No.	Nonsterile No.	Qty. Cs
29434	29434N	20

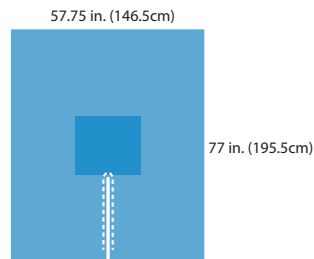

- Absorbent reinforcement, 20 x 18.5 in. (51 x 47cm)
- Split with adhesive, 1 x 28.25 in. (2.5 x 72cm)

Tiburon® Split Drape

Sterile No.	Nonsterile No.	Qty. Cs
29436	29436N	10

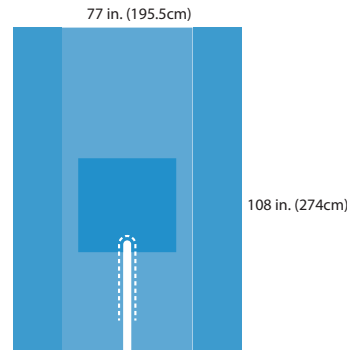

- Absorbent reinforcement, 34 x 30.5 in. (86 x 77.5cm)
- Split with adhesive, 2.5 x 37 in. (6 x 94cm)
- Included in packs 29182, 29183, 29184

Tiburon® Orthopedic Split Drape

Sterile No.	Nonsterile No.	Qty. Cs
29476	29476N	10

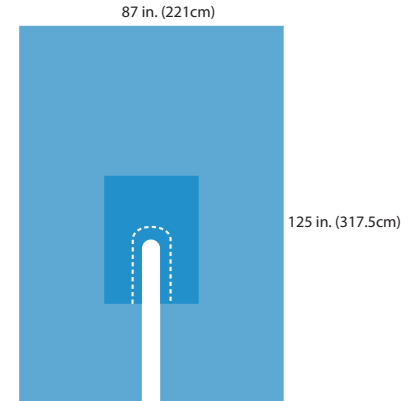

- Absorbent reinforcement, 30.5 x 42 in. (77.5 x 107cm)
- Split with adhesive, 6 x 54 in. (15 x 137cm)

Tiburon® Split Sheet Drape

Sterile No.	Nonsterile No.	Qty. Cs
29445	29445N	8

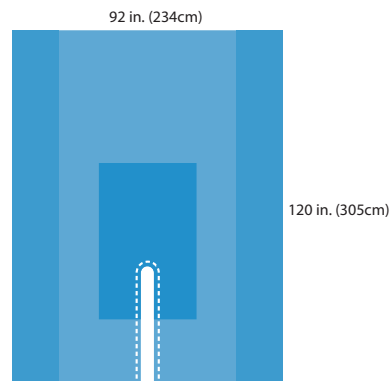

- Absorbent reinforcement, 33.5 x 53 in. (85 x 134.5cm)
- Split with adhesive, 4 x 40 in. (10 x 101cm)

Tiburon® Split Sheet Drape

Sterile No.	Nonsterile No.	Qty. Cs
29446	29446N	8

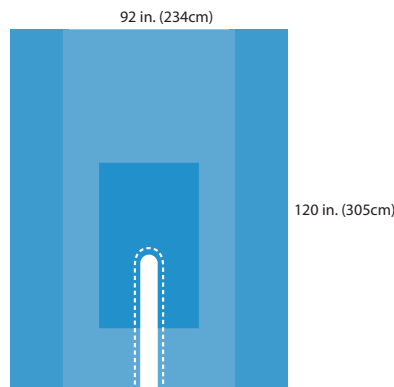

- Absorbent reinforcement, 33.5 x 53 in. (85 x 134.5cm)
- Split with adhesive, 6 x 46 in. (15 x 117cm)

Tiburon® Arthroscopy Drape for Dropped Leg Procedures

Sterile No.	Nonsterile No.	Qty. Cs
9414	9414NA	12

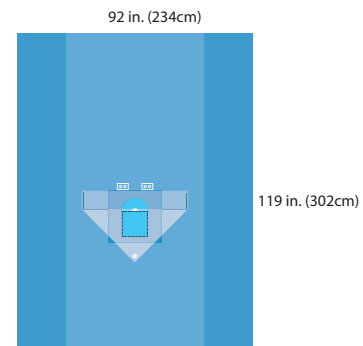

- Absorbent reinforcement, 20 x 20 in. (51 x 51cm)
- Dual fenestration, circular elastic, 2.5 in. (6cm)
- Fluid control pouch with malleable wire and port
- Cord-holding tabs



Tiburon® Surgical Drapes and Packs

Orthopedics

Tiburon® Hip Drape

Sterile No.	Nonsterile No.	Qty. Cs
29430	29430N	12

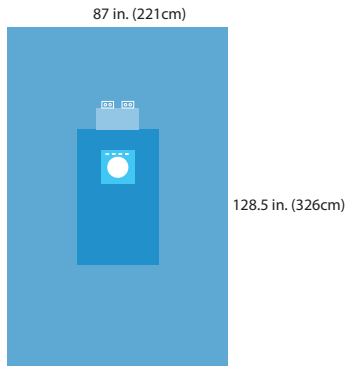

- Absorbent reinforcement, 30.5 x 50 in. (77.5 x 127cm)
- Cord-holding tabs
- Fenestration, circular elastic, 8 in. (20cm)
- Instrument pad
- Included in pack 29187

Tiburon® Hip Drape with Pouches

Sterile No.	Nonsterile No.	Qty. Cs
29439	29439N	5

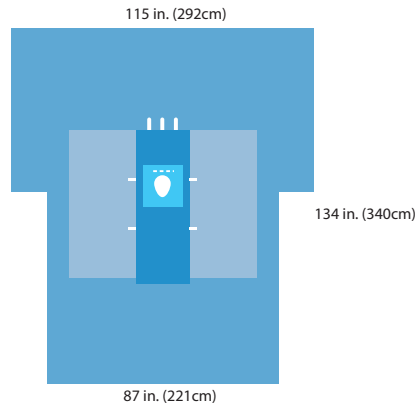

- Absorbent reinforcement, 21.375 x 57 in. (54 x 145cm)
- Anesthesia screen
- Armboard covers
- Clear leg positioning pouches, 54.5 x 30 in. (138 x 76cm)
- Fenestration, pear-shaped elastic, 6.75 x 8.25 in. (17 x 21cm)
- Velcro® Cord-Holding Tabs

Tiburon® Hand Drape

Sterile No.	Nonsterile No.	Qty. Cs
29427	29427N	18

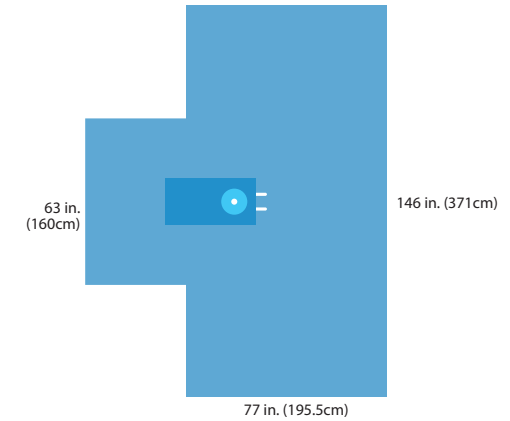

- Absorbent reinforcement, 16.75 x 34 in. (42.5 x 89cm)
- Fenestration, circular elastic, 2 in. (5cm).
- Hand table extension
- Velcro® Cord-Holding Tabs

Orthopedics

General Ortho Packs

Nonsterile No.	Description	29181 General Orthopedic Pack	29182 Orthopedic Pack
29432N	Tiburon® Split Drape with absorbent reinforcement, adhesive	1	
29351N	Tiburon® Top Drape with absorbent reinforcement, adhesive	1	
9349N	Tiburon® Fan-Folded Drape Sheet, 52 x 76 in. (132 x 193cm)		1
29436N	Tiburon® split drape, adhesive		1
9040N	Astound® Gown, poly reinforced, X-large	2	
8520N	Absorbent towel	2	
8694-60	Suture bag	1	1
8337N	Mayo stand cover, reinforced poly, 23 in. (58cm) wide	1	1
8475N	U-Drape, poly, adhesive, 60 x 84 in. (152 x 213cm), 8 x 30 in. (20 x 76cm) split	1	
8476NA	U-Drape, poly, adhesive, 60 x 72 in. (152 x 183cm), 6 x 21 in. (15 x 53cm) split		1
1582N	Stockinette, 12 x 48 in. (30.5 x 122cm), X-large	1	
8554N	Drape towel, adhesive, nonabsorbent	4	4
8143N	Outer wrap, reinforced poly table cover, 50 x 90 in. (127 x 228.6cm)	1	1
Quantity per case		4	5

Tiburon® Surgical Drapes and Packs

Orthopedics



Orthopedics

Tiburon® Extremity Drape

Sterile No.	Nonsterile No.	Qty. Cs
29405	29405N	6

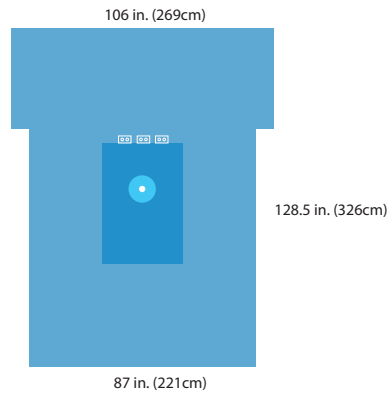

- Absorbent reinforcement, 30.5 x 45 in. (77.5 x 114cm)
- Anesthesia screen
- Armboard covers
- Cord-holding tabs
- Fenestration, circular elastic, 2.5 in. (6cm)

Tiburon® Extremity Drape

Sterile No.	Nonsterile No.	Qty. Cs
29414	29414N	12

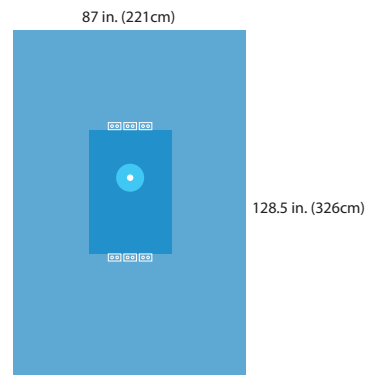

- Absorbent reinforcement, 30.5 x 45 in. (77.5 x 114cm)
- Cord-holding tabs
- Fenestration, circular elastic, 2.5 in. (6 in.)
- Included in packs 29188, 29189

Tiburon® Bilateral Limb Drape

Sterile No.	Nonsterile No.	Qty. Cs
29416	29416N	12

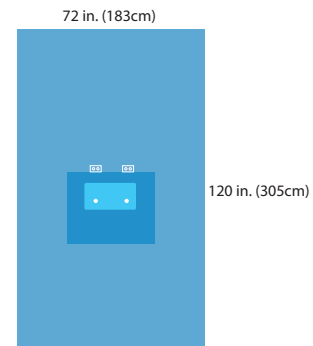

- Absorbent, reinforcement, 31 x 27 in. (79 x 68.5cm)
- Cord-holding tabs
- Dual fenestration, circular elastic, 1.5 in. (4cm)

Tiburon® Bilateral Limb Drape

Sterile No.	Nonsterile No.	Qty. Cs
29417	29417N	8

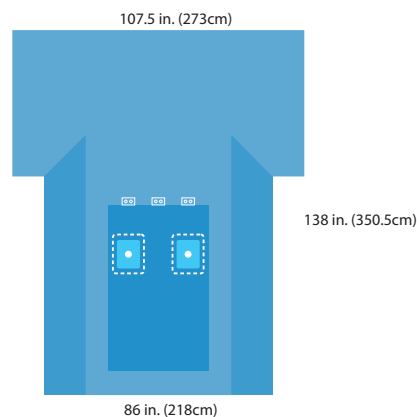

- Absorbent, reinforcement, 37.5 x 61 in. (95 x 155cm)
- Anesthesia screen
- Armboard covers
- Cord-holding tabs
- Dual fenestration, circular elastic, 2.5 in. (6cm)

Tiburon® Beach Chair Shoulder Drape

Sterile No.	Nonsterile No.	Qty. Cs
29369	29369NA	5

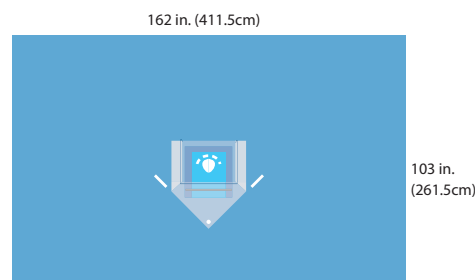

- Fenestration, pear-shaped, 5.5 x 5.75 in. (14 x 14.5cm)
- Fluid control pouch with malleable wire drawstring pouch and port
- Velcro® Cord-Holding Tabs

Tiburon® Shoulder Drape

Sterile No.	Nonsterile No.	Qty. Cs
N/A	9360N	

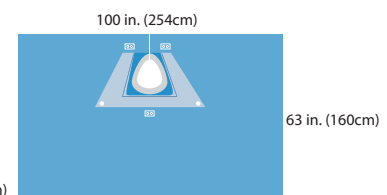

- Fenestration, pear-shaped with split and incise aperture, 11.5 x 14 in. (29 x 35.5cm)
- Fluid control pouch with drawstring and ports
- Cord-holding tabs
- Included in packs 29367



Tiburon® Split Drape

Sterile No.	Nonsterile No.	Qty. Cs
N/A	9361N	

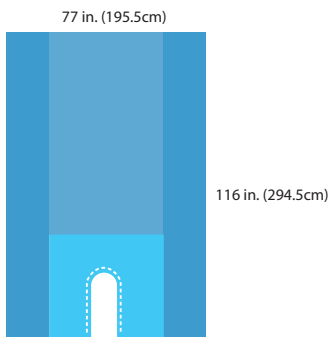

- Reinforcement, 44 x 40 in. (112 x 101.5cm)
- Split with adhesive, 10 x 25 in. (25 x 63.5cm)
- Included in packs 9183, 29367, 29365, 29160

Tiburon® Top Drape

Sterile No.	Nonsterile No.	Qty. Cs
29352	29351N	14

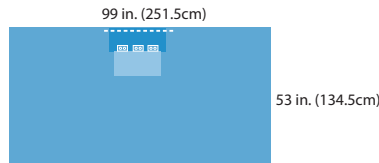

- Absorbent reinforcement, 20 x 9.375 in. (51 x 24cm)
- Cord-holding tabs
- Instrument pad
- Included in packs 29181, 29131

Orthopedics

Extremity Packs

Nonsterile No.	Description	29188 Fluid Control Extremity Pack
29414N	Tiburon® Extremity Drape	1
8694-60	Suture bag	1
8337N	Mayo stand cover, reinforced poly, 23 in. (58cm) wide	1
8375N	Plastic sheet, fan-folded, 44 x 60 in. (112 x 152cm)	1
1582N	Stockinette, 12 x 48 in. (30.5 x 122cm), X-large	
8554N	Drape towel, adhesive, nonabsorbent	2
8143N	Outer wrap, reinforced poly table cover, 50 x 90 in. (127 x 228.6cm)	1
Quantity per case		5

Shoulder Packs

Nonsterile No.	Description	29367 Fluid Control Shoulder Drape Pack	29365 Shoulder Drape Pack
9360N	Tiburon® Shoulder Drape with attached fluid control pouch, with incise	1	
9361N	Tiburon® Split Drape, poly reinforced, adhesive	1	1
Quantity per case		10	8

Tiburon® Surgical Drapes and Packs
Orthopedics



Patient Isolation Drape

Sterile No.	Nonsterile No.	Qty. Cs
D1014	D1014NS	5

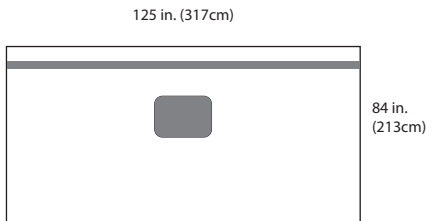

- Adhesive Area: 9.5 x 19.5 in. (24 x 50cm)
- Adhesive Strip: 125 x 0.5 in. (317 x 1.3cm)

PRODUCT KEY:  Antimicrobial Adhesive

Patient Isolation Drape

Sterile No.	Nonsterile No.	Qty. Cs
D1017	D1017NS	5

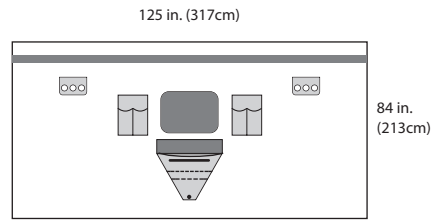

- Adhesive Area
9.5 x 19.5 in. (24 x 50cm)
- Adhesive Strip
125 x 0.5 in. (317 x 1.3cm)
- Fluid Pouch
20 x 19 in. (51 x 48cm)
- Instrument Pouches
(2) 6.7 x 11.5 in. (17 x 29cm)

PRODUCT KEY:  Adhesive  Matte Film  Clear Film



Tiburon® Surgical Drapes and Packs

Pacemaker

Tiburon® Surgical Drapes and Packs

Pacemaker

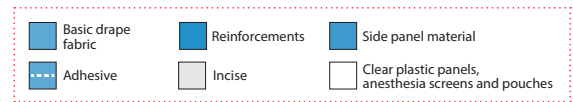

Fluoroscope Procedure Sheet

Sterile No.	Nonsterile No.	Qty. Cs
D2221	D2221NS	20

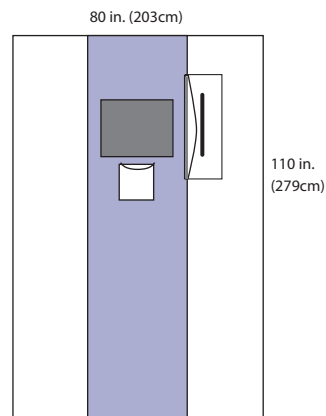

- Adhesive Area:
19.75 x 14 in. (43 x 33cm)
- Pouches:
11 x 23 in. (27 x 58cm)
8.5 x 11 in. (21 x 25cm)

Pacemaker Drape

Sterile No.	Nonsterile No.	Qty. Cs
29013	29013N	8

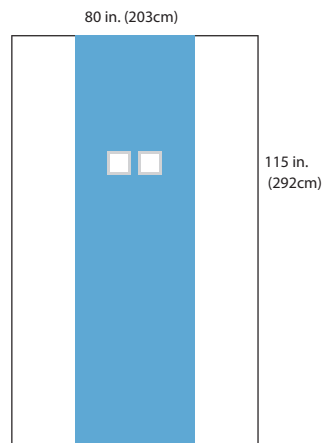

- Absorbent reinforcement, 33.5 x 115 in. (85 x 292cm)
- Clear side panels, 23 x 115 in. (58 x 292cm)
- Fenestration, dual square, 6 in. (15cm), with square incise aperture, 4 in. (10cm)

Pacemaker

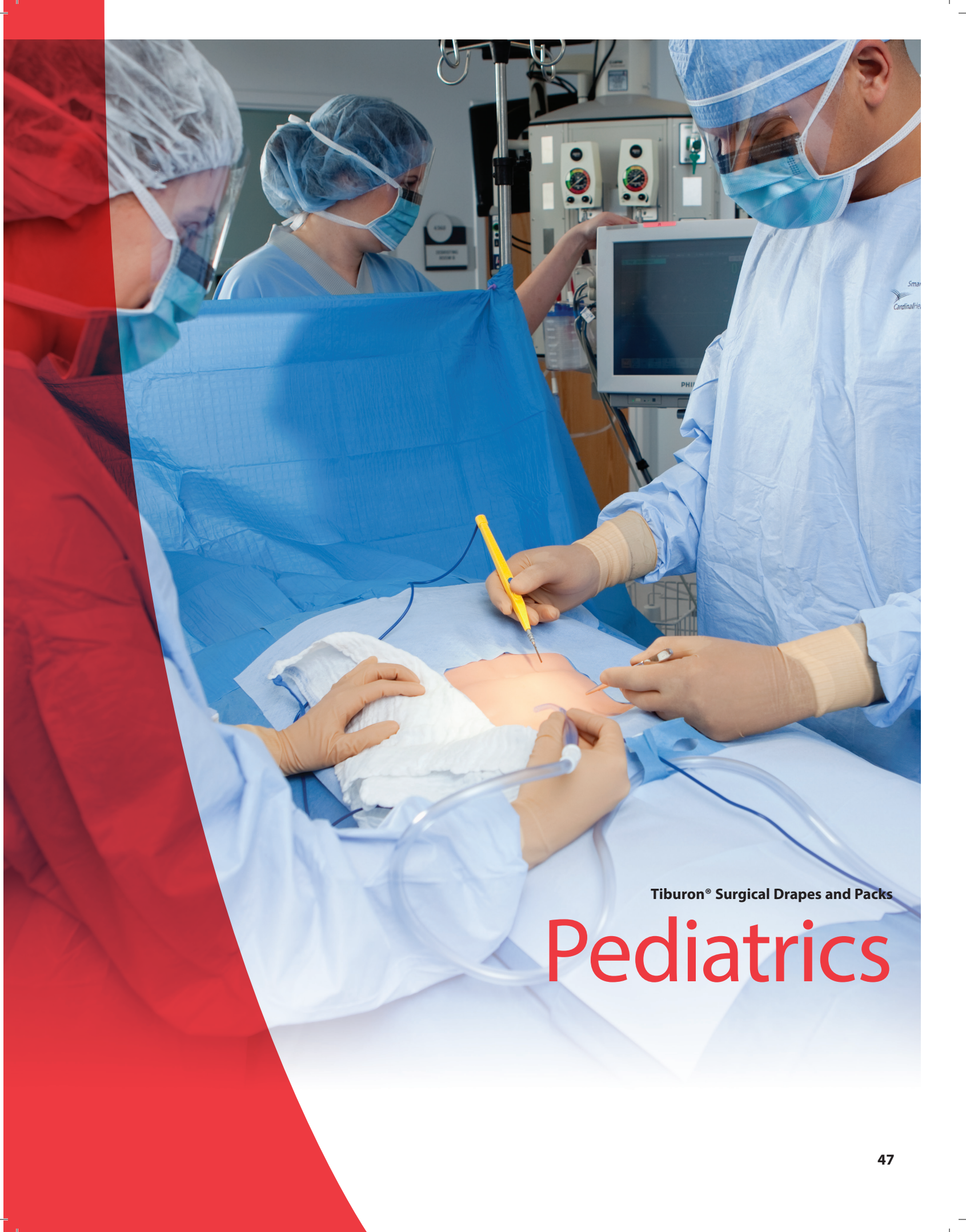

Tiburon® Surgical Drapes and Packs

Pediatrics

Tiburon® Surgical Drapes and Packs

Pediatrics

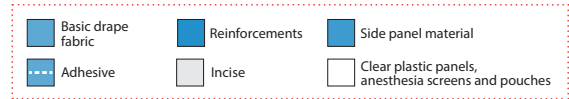

Pediatrics

Tiburon® Pediatric Drape

Sterile No.	Nonsterile No.	Qty. Cs
29492	29492N	10

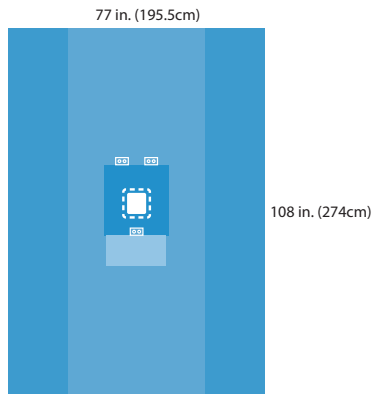

- Absorbent reinforcement, 19 x 20.375 in. (48 x 52cm)
- Cord-holding tabs
- Fenestration, 6 x 6 in. (15 x 15cm)
- Instrument pad

Tiburon® Neonatal Drape

Sterile No.	Nonsterile No.	Qty. Cs
29494	29494N	20

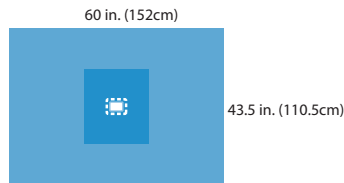

- Absorbent reinforcement, 18 x 20 in. (46 x 51cm)
- Fenestration, 3 x 4 in. (7.5 x 10cm)

Tiburon® Split Drape

Sterile No.	Nonsterile No.	Qty. Cs
29434	29434N	20

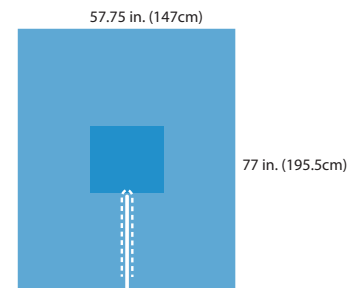

- Absorbent reinforcement, 20.375 x 18.5 in. (52 x 47cm)
- Split with adhesive, 1 x 28.25 in. (2.5 x 72cm)

Tiburon® Pediatric Directional Incision Drape

Sterile No.	Nonsterile No.	Qty. Cs
9777	9777N	60

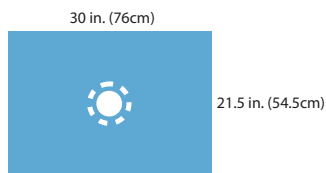

- Fenestration, circular, 4 in. (10cm)



Tiburon® Surgical Drapes and Packs

Peri-GYN

Tiburon® Surgical Drapes and Packs

Peri-GYN

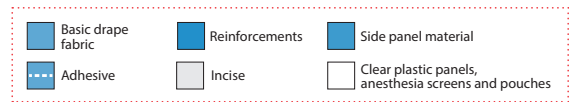

Tiburon® Lithotomy Drape

Sterile No.	Nonsterile No.	Qty. Cs
29455	29455N	8

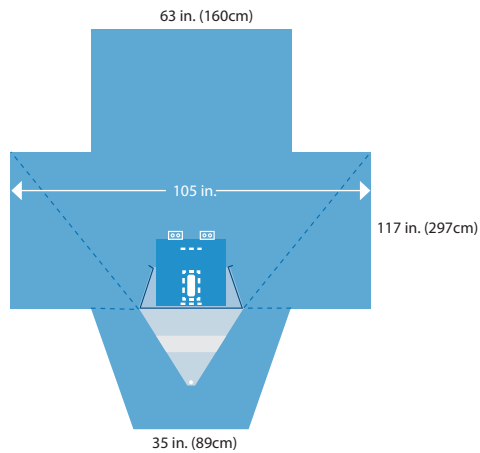

- Absorbent reinforcement, 20.375 x 19 in.
- Anesthesia screen
- Attached leggings
- Cord-holding tabs
- Fluid control pouch with filtering screen and suction port
- Rectangular perineal fenestration with adhesive, 2.5 x 6.5 in. (6 x 16.5cm)

Tiburon® LAVH Drape

Sterile No.	Nonsterile No.	Qty. Cs
29474	29474N	8

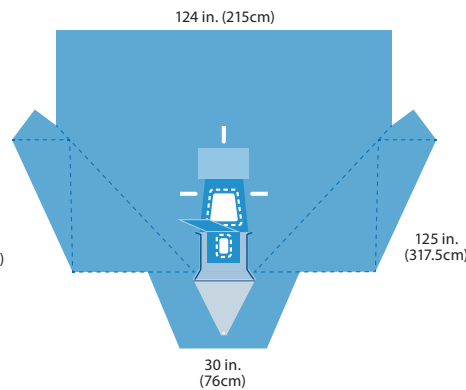

- Absorbent reinforcement, 12 x 19.25 x 16.75 in. (30.5 x 49 x 42.5cm)
- Anesthesia screen
- Armboard covers
- Attached leggings with tieback straps
- Fluid control pouch with closed suction port and drawstring
- Instrument pad
- Perineal fenestration with adhesive, 3 x 6 in. (7.5 x 15cm)
- Perineal flap
- Trapezoidal abdominal fenestration with adhesive, 7 x 9 x 9 in. (18 x 23 x 23cm)
- Velcro® Cord-Holding Tabs
- Included in pack 29475

Peri-GYN Packs

Nonsterile No.	Description	29242 Laparoscopy Pack	29146 Abdominal Lithotomy Pack	29276 Peri-GYN Pack	9165 Peri-GYN Pack
29438N	Tiburon® Lithotomy "T" Drape with absorbent reinforcement, adhesive			1	
29402N	Tiburon® Laparoscopy Drape with absorbent reinforcement, adhesive	1			
29300N	Abdominal lithotomy drape		1		
9359N	Drape sheet, adhesive				1
8483N	Under-buttocks drape, reinforced poly		1		1
8554N	Drape towel, adhesive, nonabsorbent	1		1	1
8520N	Absorbent towel	1		1	1
8421N	Pair of leggings, X-large	1		1	1
8694-60	Suture bag	1		1	1
8146N	Outer wrap, reinforced poly table cover, 44 x 90 in. (111.8 x 228cm)	1		1	1
	Quantity per case	10	8	10	12



Tiburon® Surgical Drapes and Packs

Special procedures

Special procedures



Special procedures

Special Procedure Sheet

Sterile No.	Nonsterile No.	Qty. Cs
D2224	D2224NS	20

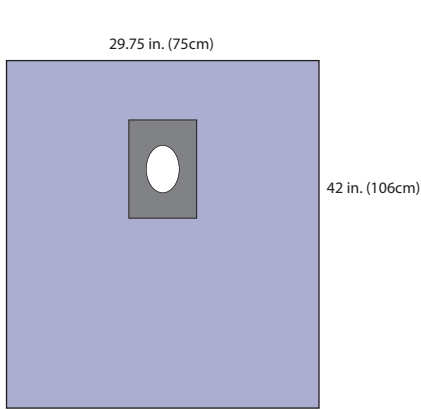

- Adhesive Areas: 8.25 x 10 in. (20 x 15cm)
- Aperture: 3.5 x 4.5 in (8 cm x 11 cm)

Fistula Drape

Sterile No.	Nonsterile No.	Qty. Cs
D2264	D2264NS	10

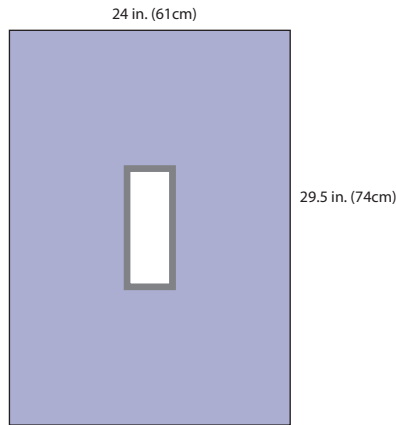

- Aperture: 3 x 9 in. (8 x 23cm)



Tiburon® Surgical Drapes and Packs

Standard packs

Standard packs

Universal Packs

Universal Pack

Sterile No. 9106

NS Cat. No.	Contents	Qty. Cs
9465N	2 Tiburon® Side Drape, adhesive	5
9468N	1 Tiburon® Foot Drape, adhesive	
9467N	1 Tiburon® Head Drape, adhesive	
8520N	1 Absorbent towel	
8337N	1 Mayo stand cover, reinforced poly, 23 in. (58cm) wide	
8694-60	1 Suture bag	
8146N	1 Outer wrap, reinforced poly table cover, 44 x 90 in. (111.8 x 228.6cm)	

Universal Pack

Sterile No. 29118

NS Cat. No.	Contents	Qty. Cs
29669N	1 Tiburon® Foot Drape with adhesive, 77 x 75 in. (195.6 x 190.5cm)	6
29667N	1 Tiburon® Head Drape with adhesive, 72 x 112 in. (182.9 x 284.5cm)	
29665N	2 Tiburon® Side Drape with tape, 44 x 77 in. (111.8 x 195.6cm)	
8554N	4 Drape towel, adhesive, nonabsorbent	
8337N	1 Mayo stand cover, reinforced poly, 23 in.(58cm) wide	
8694-60	1 Suture bag	
8146N	1 Outer wrap, reinforced poly table cover, 44 x 90 in. (111.8 x 228.6cm)	
8520N	1 Absorbent towel	

Universal Split Pack

Sterile No. 29131

NS Cat. No.	Contents	Qty. Cs
29440NA	1 Tiburon® Split Drape with absorbent reinforcement	4
29351N	1 Tiburon® Top Drape, absorbent reinforcement/ instrument pad 53 x 99 in. (134.6 x 251.5cm)	
8554N	4 Drape towel, adhesive, nonabsorbent	
8337N	1 Mayo stand cover, reinforced poly, 23 in. (58cm) wide	
8694-60	1 Suture bag	
8143N	1 Outer wrap, reinforced poly table cover, 50 x 90 in. (127 x 228.6cm)	

Laparotomy Packs

Laparotomy Pack Sterile No. 29136

NS Cat. No.	Contents	Qty. Cs	5
9358N	1 Tiburon® Fan-Folded Drape Sheet, 40 x 57 in. (101 x 145cm)		
29410N	1 Tiburon® Laparotomy Drape with absorbent reinforcement and armboard covers		
8554N	4 Drape towel, adhesive, nonabsorbent		
8520N	1 Absorbent towel		
8337N	1 Mayo stand cover, reinforced poly, 23 in. (58cm) wide		
8694-60	1 Suture bag		
8143N	1 Outer wrap, reinforced poly table cover, 50 x 90 in. (127 x 228.6cm)		

Cystoscopy Packs

Cystoscopy Pack Sterile No. 29480

NS Cat. No.	Contents	Qty. Cs	14
8694-60	1 Suture bag		
8520N	1 Absorbent towel		
8421N	1 Pair of leggings, X-large		
29437NA	1 Cystoscopy T-drape		
8145N	1 Outer wrap, reinforced poly table cover, 44 x 75 in. (111.8 x 190.5cm)		

Cystoscopy Pack Sterile No. 29360

NS Cat. No.	Contents	Qty. Cs	10
8694-60	1 Suture bag		
8520N	1 Absorbent towel		
29451N	1 Tiburon® Urological Drape		
8145N	1 Outer wrap, reinforced poly table cover, 44 x 75 in. (111.8 x 190.5cm)		

Obstetrics Pack

Obstetrics Pack Sterile No. 29920

NS Cat. No.	Contents	Qty. Cs	6
29357N	1 Tiburon® Abdominal Cover with absorbent reinforcement		
8421N	1 Pair of leggings, X-large		
8483N	1 Under-buttocks drape, reinforced poly		
8365N	1 Setup cover, 44 x 71 in. (111.8 x 180.3cm)		
8520N	2 Absorbent towel		
8145N	1 Outer wrap/reinforced poly table cover, 44 x 75 in. (111.8 x 190.5cm), reinforcement 24 x 75 in. (61 x 190.5cm)		

Standard packs

Head and Neck Packs

Head and Neck Pack

Sterile No. 9195

NS Cat. No.	Contents	Qty. Cs	8
9557N	1 Tiburon® Bar Drape, adhesive		
9443N	1 Tiburon® Split Sheet, unreinforced, adhesive		
9515NA	1 Astound® Standard Gown, sterile back		
8554N	2 Drape towel, adhesive, nonabsorbent		
8337N	1 Mayo stand cover, reinforced poly, 23 in. (58cm) wide		
8694-60	1 Suture bag		
8146N	1 Outer wrap, reinforced poly table cover, 44 x 90 in. (111.8 x 228.6cm)		

Head and Neck Pack

Sterile No. 9196

NS Cat. No.	Contents	Qty. Cs	6
9556N	1 Tiburon® Head/Bar Drape, adhesive		
9447N	1 Tiburon® Large ENT Split Drape		
90270NA	1 Astound® Standard Scrub Nurse Gown, large, with towel in outer wrap		
9515NA	1 Astound® Standard Gown, sterile back, large		
8520N	1 Absorbent towel		
8337N	1 Mayo stand cover, reinforced poly, 23 in. (58cm) wide		
8694-60	1 Suture bag		
8554N	2 Drape towel, adhesive, non-absorbant		
8146N	1 Outer wrap, reinforced poly table cover, 44 x 90 in. (111.8 x 228.6cm)		

Orthopedic Packs

General Orthopedic Pack

Sterile No. 29181

NS Cat. No.	Contents	Qty. Cs	4
29432N	1 Tiburon® Split Drape with absorbent reinforcement, adhesive		
29351N	1 Tiburon® Top Drape with absorbent reinforcement 53 x 99 in. (134.6 x 251.5cm), adhesive		
9040N	2 Astound® Reinforced Gown, X-large		
8520N	2 Absorbent towel		
8694-60	1 Suture bag		
8337N	1 Mayo stand cover, reinforced poly, 23 in. (58cm) wide		
8475N	1 U-Drape, poly, adhesive, 60 x 84 in. (152.4 x 213.4cm)		
1582N	1 Stockinette, 12 x 48 in. (30.5 x 121.9cm), X-large		
8554N	4 Drape towel, adhesive, nonabsorbent		
8143N	1 Outer wrap, reinforced poly table cover, 50 x 90 in. (127 x 228.6cm)		

Orthopedic Pack

Sterile No. 29182

NS Cat. No.	Contents	Qty. Cs	5
9349N	1 Tiburon® Fan-Folded Drape Sheet, 52 x 76 in. (132 x 193cm)		
29436N	1 Tiburon® Split Drape, adhesive		
8694-60	1 Suture bag		
8337N	1 Mayo stand cover, reinforced poly, 23 in. (58cm) wide		
8476NA	1 Prep U-drape, 60 x 72 in. (152.4 x 182.9cm)		
A8554N	4 Drape towel, adhesive, nonabsorbent		
A8143N	1 Outer wrap, reinforced poly table cover, 50 x 90 in. (127 x 228.6cm)		

Standard packs

Extremity Packs

Extremity Pack

Sterile No. 29188

NS Cat. No.	Contents	Qty. Cs
29414N	1 Tiburon® Extremity Drape	5
8694-60	1 Suture bag	
8337N	1 Mayo stand cover, reinforced poly, 23 in. (58cm) wide	
8375N	1 Plastic sheet, fan-folded, 44 x 60 in. (111.8 x 152.4cm)	
8554N	2 Drape towel, adhesive, nonabsorbent	
8143N	1 Outer wrap, reinforced poly table cover, 50 x 90 in. (127 x 228.6cm)	

Shoulder Packs

Fluid Control Shoulder Drape Pack

Sterile No. 29367

NS Cat. No.	Contents	Qty. Cs
9360N	1 Tiburon® Shoulder Drape with attached fluid control pouch, with incise	10
9361N	1 Tiburon® Split Drape, poly reinforced, adhesive	

Laparoscopy Packs

Laparoscopy Pack

Sterile No. 29242

NS Cat. No.	Contents	Qty. Cs
29402N	1 Tiburon® Laparoscopy Drape with absorbent reinforcement, adhesive	10
8554N	1 Drape towel, adhesive, nonabsorbent	
8520N	1 Absorbent towel	
8421N	1 Pair of leggings, X-large	
8694-60	1 Suture bag	
8146N	1 Outer wrap, reinforced poly table cover, 44 x 90 in. (111.8 x 228.6cm)	

Abdominal Lithotomy Pack

Sterile No. 29146

NS Cat. No.	Contents	Qty. Cs
29300N	1 Tiburon® Abdominal Lithotomy Drape	8
8483N	1 Under-buttocks drape, reinforced poly	

Tiburon® Surgical Drapes and Packs
Standard packs

Standard packs

Peri-GYN and Laparoscopy Packs

Peri-GYN Pack **Sterile No. 29276**

NS Cat. No.	Contents	Qty. Cs	10
29438N	1 Tiburon® Lithotomy "T" Drape with absorbent reinforcement, adhesive		
8554N	1 Drape towel, adhesive, nonabsorbent		
8520N	1 Absorbent towel		
8421N	1 Pair of leggings, X-large		
8694-60	1 Suture bag		
8146N	1 Outer wrap, reinforced poly table cover, 44 x 90 in. (111.8 x 228.6cm)		

Peri-GYN Pack **Sterile No. 9165**

NS Cat. No.	Contents	Qty. Cs	12
9359N	1 Drape sheet, adhesive 38.5 x 56 in. (97.8 x 142.2cm)		
8483N	1 Under-buttocks drape, reinforced poly		
8421N	1 Pair of leggings, X-large		
8520N	1 Absorbent towel		
8554N	1 Non-absorbent towel with adhesive strip		
8694-60	1 Suture bag		
8146N	1 Outer wrap, reinforced poly table cover, 44 x 90 in. (111.8 x 228.6cm)		

Sterile Number Index

1584.....	10	29476.....	40
1585.....	10	29480.....	22, 55
1586.....	10	29492.....	48
1587.....	10	29494.....	48
29013.....	46	29527.....	20
29118.....	26, 54	29529.....	14
29131.....	26, 54	29570.....	14
29136.....	26, 55	29920.....	31, 55
29146.....	50, 58	32474.....	5
29153.....	18	3524.....	11
29154.....	17	39015.....	5
29181.....	41, 57	39045.....	5
29182.....	41, 57	39049.....	5
29188.....	43, 58	39075.....	5
29242.....	50, 58	39079.....	5
29276.....	50, 59	39099.....	5
29322.....	20	59405.....	39
29352.....	24, 43	59413.....	39
29360.....	22, 55	59439.....	39
29365.....	43	599.....	5
29367.....	43, 58	7444.....	33
29369.....	42	7445.....	33
29405.....	42	8186.....	12
29410.....	24	8337.....	12
29414.....	42	8339.....	12
29416.....	42	8376.....	12
29417.....	42	8377.....	12
29418.....	28	8378.....	12
29420.....	25	8420.....	10
29422.....	24	8430.....	10
29427.....	41	8441.....	33
29430.....	41	8475.....	10
29434.....	40, 48	8476.....	10
29436.....	40	8482.....	9
29439.....	41	8483.....	9
29440.....	24	8484.....	9
29443.....	30	8487.....	9
29445.....	40	89005.....	5
29446.....	40	89015.....	5
29447.....	30	89045.....	5
29448.....	30	89075.....	5
29449.....	30	9010.....	5
29452.....	30	9040.....	5
29455.....	22, 50	9070.....	5
29456.....	14	9106.....	26, 54
29458.....	15	9154.....	17
29460.....	14	9155.....	17
29474.....	50	9156.....	17

Sterile Number Index

9162.....	17
9165.....	50, 59
9195.....	37, 56
9196.....	37, 56
9349.....	8
9355.....	8
9358.....	8
9414.....	40
9428.....	25
9430.....	24
9439.....	28
9444.....	8
9446.....	8
9447.....	35
9448.....	28
9457.....	25
9458.....	25
94590.....	25
9461.....	9
9462.....	8
9556.....	36
9562.....	33
9777.....	48

A

ASG9511.....	5
ASG9515.....	5
ASG9541.....	5
ASG9541EL.....	5
ASG9545.....	5
ASG9575.....	5

D

D1000.....	8
D1003.....	11

D1010.....	8
D1012.....	12
D1014.....	44
D1015.....	10
D1016.....	11
D1017.....	44
D1018.....	11
D1018L.....	11
D1019.....	10
D1020.....	34
D1021.....	34
D1024.....	35
D1025.....	34
D1031.....	33
D1060.....	34
D1061.....	34
D1071.....	22
D1072.....	11
D1089.....	8
D1122.....	35
D1195.....	14
D2008A.....	12
D2019.....	34
D2020.....	35
D2043.....	35
D2158.....	12
D2221.....	46
D2224.....	52
D2244.....	14
D2258.....	33
D2264.....	52

T

TB9441.....	36
-------------	----

Nonsterile Number Index

1582N	10, 41, 43, 57	29492N	48
1585N	10	29494N	48
1586N	10	29527N	20
29013N	46	29529N	14
29154N	17	29570N	14
29300N	50, 58	29665N	24, 26, 54
29322N	20	29667N	24, 26, 54
29351N	24, 26, 41, 43, 54, 57	29669N	24, 26, 54
29357N	30, 31, 55	32474N	5
29365	43	39015N	5
29369NA	42	39045N	5
29402N	50, 58	39049N	5
29405N	42	39075N	5
29410N	24, 26, 55	39079N	5
29414N	42-43, 58	39099N	5
29416N	42	59405N	39
29417N	42	59413N	39
29418N	28	59439N	39
29420N	25	7444N	33
29422N	24	7445N	33
29427N	41	7554N	18
29430N	41	8143N	18, 26, 41, 43, 54-55, 57-58
29432N	41, 57	8145N	12, 22, 31, 55
29434N	40, 48	8146N	12, 26, 37, 50, 54, 56, 58-59
29436N	40-41, 57	8152N	18
29437NA	22, 55	8184N	12
29438N	50, 59	8186N	12
29439N	41	8188N	18
29440NA	24, 26, 54	8337N	12, 18, 26, 37, 41, 43, 54-58
29443N	30	8339NI	12
29445N	40	8365N	31, 55
29446N	40	8375N	43, 58
29447N	30	8420NA	10
29448N	30	8421N	22, 31, 50, 55, 58-59
29449N	30	8430NA	10
29451N	22, 55	8441N	33
29452N	30	8470N	18
29455N	50	8475N	10, 41, 57
29455NA	22	8476NA	10, 41, 57
29456N	14	8482N	9
29458N	15	8483N	9, 31, 50, 55, 58, 59
29460N	14	8484N	9
29462N	18	8487N	9
29464N	18	8520N	18, 22, 26, 31, 37, 41, 50, 54-59
29467N	18	8554N	18, 26, 37, 41, 43, 50, 54-59
29468N	18	8694-60	18, 22, 26, 37, 41, 43, 50, 54-59
29474N	50	89005N	5
29476N	40	89015N	5

Nonsterile Number Index

89045N.....	5
89075N.....	5
9010NA.....	5
90270NA.....	37, 56
9040N.....	18, 41, 57
9040NA.....	5
90680NA.....	18
9070N.....	5
90780N.....	18
9150N.....	18
9154N.....	17-18
9155N.....	17
9156N.....	17
9158N.....	18
9162N.....	17
9349N.....	8, 18, 41, 57
9355N.....	8
9358N.....	8, 26, 55
9359N.....	50, 59
9360N.....	42-43, 58
9361N.....	43, 58
9414NA.....	40
9428NA.....	25
9430N.....	24
9439N.....	28
9441N.....	36
9443N.....	35, 37, 56
9444N.....	8
9446N.....	8
9447N.....	35, 37, 56
9448N.....	28
9457N.....	25
9458N.....	25
94590N.....	25
9460N.....	18
9461N.....	9
9462N.....	8
9465N.....	24, 54
9467N.....	24, 54
9468N.....	24, 54
9511N.....	5
9515NA.....	5, 37, 56
9541ELNA.....	5
9541N.....	5, 18

9545NA.....	5
9556N.....	36-37, 56
9557N.....	36-37, 56
9562N.....	33
9575NA.....	5
9777N.....	48

A

A8143N.....	57
A8554N.....	57

D

D1000NS.....	8
D1003NS.....	11
D1010NS.....	8
D1012NS.....	12
D1014NS.....	44
D1015NS.....	10
D1016NS.....	11
D1017NS.....	44
D1018LNS.....	11
D1018NS.....	11
D1019NS.....	10
D1020NS.....	34
D1021NS.....	34
D1024NS.....	35
D1025NS.....	34
D1031NS.....	33
D1060NS.....	34
D1061NS.....	34
D1071NS.....	22
D1072NS.....	11
D1089NS.....	8
D1195NS.....	14
D2008NS.....	12
D2019NS.....	34
D2020NS.....	35
D2043NS.....	35
D2158NS.....	12
D2221NS.....	46
D2224NS.....	52
D2244NS.....	14
D2264NS.....	52

Product Index

B

Bags

Isolation Bags.....	11
---------------------	----

C

Covers

Equipment Covers.....	12
Heavy-Duty Back Table Covers	12
Mayo Stand Covers.....	12
Standard Back Tables Covers.....	12

D

Drapes

Angiography

Angiography Sheet.....	14
Extra Large Femoral Angiography Drape	14
Radial/Femoral Angiography Drape.....	14
Tiburon® Brachial Angiography Drape	15
Tiburon® Femoral Angiography Drape.....	14

Cardiovascular

Tiburon® Bottom Drape with Reinforcement.....	18
Tiburon® Cardiovascular Incise Drape	17
Tiburon® Cardiovascular Peri-Groin Drape.....	17
Tiburon® Cardiovascular Split Drape.....	17
Tiburon® Cardiovascular Split Drape with Pouches.....	17
Tiburon® Head, Side and Foot Drapes	18

Central line

Full Body Central Line Drape.....	20
Full Body Central Line Insertion Drape.....	20

Cystoscopy

Tiburon® Cystoscopy "T" Drape	22
Tiburon® Lithotomy Drape with Fluid Control Pouch.....	22
Tiburon® Urological Drape.....	22
Urological Drape.....	22

General surgery

Tiburon® Bariatric Drape.....	25
Tiburon® Chest/Breast Drape.....	25
Tiburon® Craniotomy Split Drape.....	28
Tiburon® General Endoscopy Drape.....	25
Tiburon® Head, Side and Foot Drape	24
Tiburon® Laparoscopic Cholecystectomy Drape with Pouches.....	25
Tiburon® Laparotomy Drape	24
Tiburon® Laparotomy Drape with Pouches	24
Tiburon® Major Abdominal Drape with Pouches	25

Drapes, continued

General surgery

Tiburon® Neurological Drape.....	28
Tiburon® Thyroid Drape	24
Tiburon® Universal Pack.....	24
Tiburon® Universal Spine Drape	28
Tiburon® Universal Split Pack.....	24

Obstetrics

Tiburon® Abdominal Cover.....	30
Tiburon® Cesarean Birth Drape	30

Ophthalmology and ENT

Aperture Drape	34
Ophthalmic Aperture Drape	33, 35
Ophthalmic Drape	33
Ophthalmic Drape with Pouch.....	33
Ophthalmic Incise Drape.....	33, 34
Ophthalmic Incise Pouch	34
Refractive Drape	35
Small Drape with Adhesive Aperture.....	33
Strabismus Drape.....	35
Tiburon® Bar Drape.....	36
Tiburon® ENT Split Drape	35
Tiburon® Head/Bar Drape.....	36
Tiburon® Large ENT Split Drape	35-36

Orthopedics

Patient Isolation Drape.....	44
Tiburon® Arthroscopy Drape for Dropped Leg Procedures	40
Tiburon® Beach Chair	
Shoulder Drape	42
Tiburon® Bilateral Limb Drape	42
Tiburon® Extremity Drape	42
Tiburon® Hand Drape	41
Tiburon® Hip Drape	41
Tiburon® Hip Drape with Pouches	41
Tiburon® Orthopedic Split Drape	40
Tiburon® Shoulder Drape	42
Tiburon® Split Drape	40, 43
Tiburon® Split Sheet Drape.....	40
Tiburon® Top Drape.....	43

Orthopedics - Heavy Duty

Tiburon® HD Arthroscopy Drape	39
Tiburon® HD Extremity Drape.....	39
Tiburon® HD Hip Drape with Pouches	39

Pacemaker

Fluoroscope Procedure Sheet.....	46
Pacemaker Drape	46

Product Index

Drapes, continued

Pediatrics

Tiburon® Neonatal Drape	48
Tiburon® Pediatric Directional Incision Drape	48
Tiburon® Pediatric Drape	48
Tiburon® Split Drape	48

Peri-GYN

Tiburon® LAVH Drape	50
Tiburon® Lithotomy Drape	50
Poly U-Drapes	10

Special procedures

Fistula Drape	52
Special Procedure Sheet	52
Under-Buttocks Drapes	9

G

Gowns, Surgical

Astound® Fabric-Reinforced Gowns	5
Astound® Poly-Reinforced Gowns	5
Astound® Standard Gowns	5
SmartGown™ Surgical Gowns	5

L

Leggings

Leggings	10
----------------	----

P

Packs

Abdominal Lithotomy Packs	50, 58
Cardiovascular Packs	18
Cardiovascular Pack with reinforced Gowns	18
Cystoscopy Packs	22, 55

Packs, continued

Extremity Packs	43, 58
Fluid Control Extremity Packs	43
Fluid Control Shoulder Drape Packs	58
General Orthopedic Packs	41, 57
Head and Neck Packs	37, 56
Laparoscopy Packs	50, 58
Laparotomy Packs	26, 55
Lithotomy Packs	58
Obstetrics Packs	31, 55
Orthopedic Packs	41, 57
Peri-GYN Packs	50, 59
Shoulder Packs	43, 58
Universal Packs	26, 54
Universal Split Packs	26, 54

Pouches

Pouches	11
---------------	----

S

Sheets

Drape Sheets	8
Drape Sheet, Square-Folded	9

Sleeves

Sterile Disposable Sleeve	5
---------------------------------	---

Stockinettes

Stockinettes	10
--------------------	----

T

Tape

Adhesives and Drape Tape	11
--------------------------------	----

Towels

Drape Towels	8
--------------------	---

This literature piece is for distribution through ISKUS HEALTH in the United Kingdom and Ireland only.

© 2015 Cardinal Health. All Rights Reserved. CARDINAL HEALTH, the Cardinal Health LOGO, ESSENTIAL TO CARE, ASTOUND, SMARTGOWN AND TIBURON are trademarks or registered trademarks of Cardinal Health. All other marks are the property of their respective owners. Lit. No. 2PERI15-269739 (09/2015). PRC (09/2015).



Distributed by



www.iskushealth.com

Customer Services and Distribution Contact Details

Ireland

Iskus Health Ltd
21 Fonthill Business Park
Fonthill Road
Dublin 22

Tel: +353 1 404 8383

Fax: +353 1 404 8381

From Northern Ireland

Tel: 0845 850 8600

Fax: 0845 850 8601

Email: info@iskushealth.com

United Kingdom

Iskus UK Ltd.
B1-B2 Bond Close
Kingsland Business Park
Basingstoke
RG24 8PZ

Tel: +44 (0) 1256365458

Fax: +44 (0) 1256365459

Email: uksales@iskushealth.com